

ALGIZ 10X

MANUAL



handheld

SAFETY PRECAUTIONS

Warning



Always completely disconnect the power cord from the device before you uncover the device and work on the hardware. Do not connect the electronic device with a power socket while the power is on. Sensitive electronic components can be damaged by sudden power surges. Only experienced electronics personnel should open mechanical housing.

Caution



Always ground yourself to remove any static charge before touching the printed circuit board. The electronic devices are very sensitive to static electricity. For safety purposes, please use a grounding wrist strap at all times. Place all electronic components in a static-dissipative surface or static-shielded bag when they are outside of the chassis.





INDEX

PART 1:.....	5
IDENTIFYING ALGIZ 10X	5
GETTING STARTED	5
What's in the Box	6
Specification	7
COM Port Assignment	8
COM Port Assignment	8
Boot Options	8
Factory Reset.....	8
Front Side.....	9
Left and Right Side.....	10
Rear Side	11
Function Keys	12
LED Indicators.....	12
Part 2:.....	13
Using ALGIZ 10X	13
AC Power	14
Battery Power.....	14
Insertion of the Battery Pack	15
Removal of the Battery Pack.....	15
Charging the Battery	16
Battery Care	16
Battery Power System.....	16
Charging the Battery	16
Power Supply	16
Starting ALGIZ 10X	18
Screen Calibration.....	18
Installing WWAN Module	19
Installing SIM Card, SD Card	20
Part 3:.....	21
Software.....	21
Hot-Tab	22
Adjusting the LCD Brightness	22
Adjusting the Speaker Volume.....	24
Battery Status.....	26
WLAN27	

Bluetooth	28
WWAN (LTE) - Optional.....	29
GPS.....	30
Camera.....	32
External GPS Antenna	35
External WWAN Antenna.....	36
System Information	37
Part 4:.....	38
Regulatory Information.....	38
FCC Compliance Statement	39
FCC Warning	39
Caution:	39
FCC RF Radiation Exposure.....	39
CE Declaration of Conformity.....	Fel! Bokmärket är inte definierat.
Part: 5.....	40
ALGIZ 10X Care.....	40
Battery Protection Tips.....	41
Touch Screen Protection Tips.....	42
ALGIZ 10X Care.....	42
Cleaning the Exterior.....	43
Connectors	43
Copyright Notice.....	43
Trademark Acknowledgement	43
Disclaimer.....	43
Customer Service.....	44

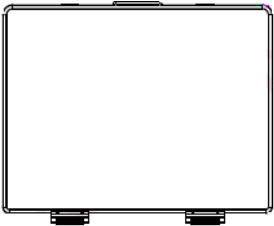
PART 1:
IDENTIFYING ALGIZ 10X
GETTING STARTED

What's in the Box

Item	Description
	One 2 Cell Li-Ion Battery Pack
	19V Adapter w/ standard power cord. Standard type, 1.8M
	Screen protector film
	ALGIZ 10X Quick start guide

Specification

ALGIZ 10X is a rugged tablet PC designed for use in various challenging environments, e.g. field work, outdoor activities and construction sites. With its rugged design, ALGIZ 10X is able to withstand shocks, vibrations, high humidity as well as high/ low temperatures.

System	
Processor	Intel® Celeron® N2930 Quad Core 1.83 GHz Processor
BIOS	AMI System BIOS
Chipset	Intel ATOM Soc Integrated
Memory	SODIMM, DDR3L 1600 4GB
LAN Controller	Intel® Ethernet Controller I211-AT
Storage	SATA interface support Mini-PCIe interface SSD 128GB
Audio	Audio-out / Audio-in / Microphone-in. Internal Speaker

Display Specification	
Size	10.1" (16:9)
Resolution	1366 x 768
Brightness	600 cd/m2 (typ.)
Touch	4W Resistive Touch

I/O Connectors	
Left Side	1xDC Power Jack, 1xVGA, 1Xusb 2.0,1xRS232
Right Side	1xLAN, 1xUSB 3.0, 1xMic/Audio Jack, 1xSIM Card Slot, 1xMicro SD Card Slot
Bottom Side	Pogo-pin for docking
Rear Side	Service Window

Buttons and Indicators	
Control Button	Power On/Off, Menu, Up, Down, Left, Right, Enter, 3 Programmable Hotkeys
LED Indicators	Power Status, SSD Status, RF Device Status, Battery Status, GPS Status

COM Port Assignment

COM1	RS232
COM2	B+ Power & UART Wafer
COM3	GPS
COM6	WWAN virtual COM
COM7	WWAN virtual COM
COM8	WWAN virtual COM
COM11	Docking Station
COM12	Docking Station

Boot Options

F1	Initiate factory reset
F2	Enter BIOS
F3	-

Factory Reset

The ALGIZ 10X has a built-in recovery utility that can be used to reset your computer's SSD disk to its factory state. Press **F1** during booting when the Handheld logo screen appears. Follow the instructions on the screen to continue with the factory reset.



CAUTION: This procedure will erase all data on your disk.

Front Side



Ref.	Item	Description
1	Front Microphone	Receives sound to make voice recordings.
2	Light Sensor	Senses the ambient light for automatic adjustment of the display backlight. The features can be enabled through the OSD Control Keypad.
3	OSD Control Keypad	The OSD Control Keypad provides hotkeys with all functions including Power On/Off, Menu, Up, Down, Left, Right, Enter and programmable hotkey , Windows chrome menu key and Windows Home key..
4	Speaker	Front Speaker

Left and Right Side

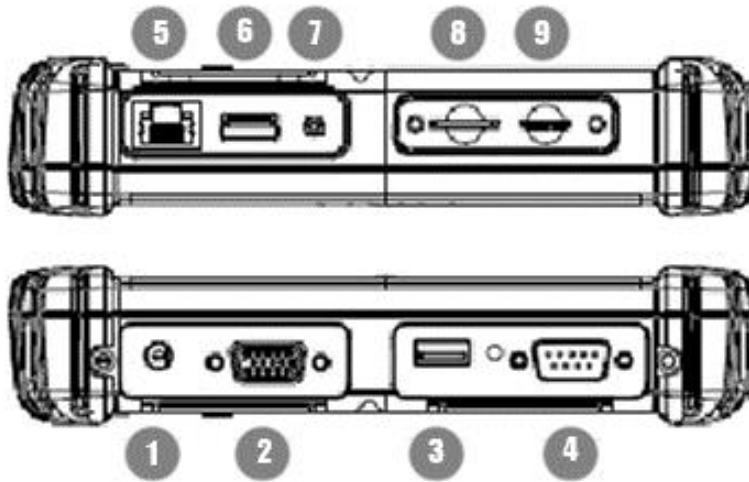

Ref.	Item	Description
1	DC Power Jack	DC plug for supplying power to the device
2	VGA	For connection to external display devices such as monitors and projectors
3	USB 2.0 Port	Can be connected to USB-interface peripherals
4	RS232	Accepts external connections using the interface of RS232 (D-sub 9 pins)
5	Ethernet(RJ45) Port	For connection to an Ethernet 10/100/1000-based network
6	USB 3.0 Port	Can be connected to any USB-interface peripherals
7	Combo Audio Jack	For connection to a set of headphones or external speakers.
8	SIM Card Slot	Accepts a SIM Card, use the WWAN feature to connect to the Internet.
9	Micro SD Card Slot	Accepts a Micro SD Card for additional features.

Rear Side

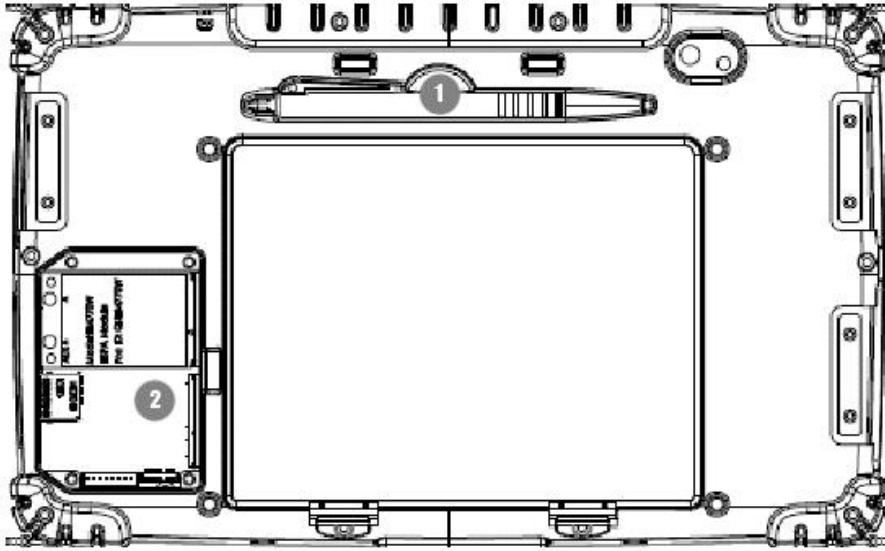

	Item	Description
1	Stylus Pen	
2	Service Window	User-accessible compartment.

Function Keys

Components	Description
Power Button*	Hold down for 4 seconds to turn the computer on.
Menu	Menu button to control: brightness, volume, battery, power to modules, and system information.
Up/Down/Left/Right/OK Button	Control of up, down, left, right and Enter functions.
F1	Programmable button. Press F1 to configure.
F2	Windows 8 Chrome menu. Press F1 to configure.
Windows 8 Home Key	Functions as the windows key on a normal keyboard/laptop. Press F1 to configure.

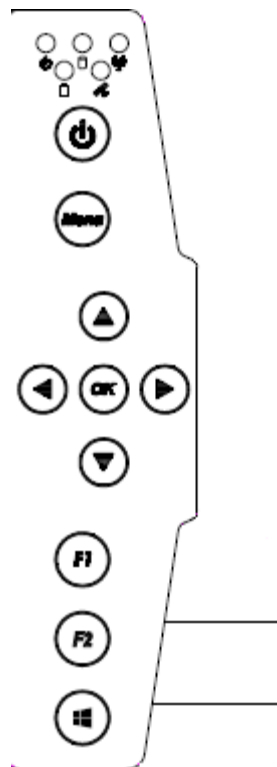

* If computer does not respond you can power it off by holding down the Power Button until the LEDs are switched off. Hold down for about 10 seconds.

LED Indicators

LED Term	Symbol	Indicator Status Description
Power mode		Green: System is on No light: System is off or LED indicators are off in Hot-tab.
Storage Status		Flashing green light: SSD is reading/writing data
Radio Status		Green: Indicates that any transmitting radio is turned on. (WiFi, BT, WWAN)
Battery Status		Green: Full battery Red: Low battery Orange: Charging Flashing red: Running on Hot-swap battery
GPS Status		Green: GPS is on.

PART 2: USING ALGIZ 10X

Before turning the unit on, make sure that the tablet is either connected to AC power or the battery.

AC Power

The ALGIZ 10X power supply is comprised of two parts, the power adapter and the battery. The power adapter converts AC power from a wall outlet to the DC power required by the ALGIZ 10X. Your ALGIZ 10X comes with a universal AC-DC adapter. That means that you may connect the power cord to any 100V-120V as well as 220V-240V outlets without using power converters. Different countries may require an adapter to be used to connect the supplied standard AC power cord to a different standard.

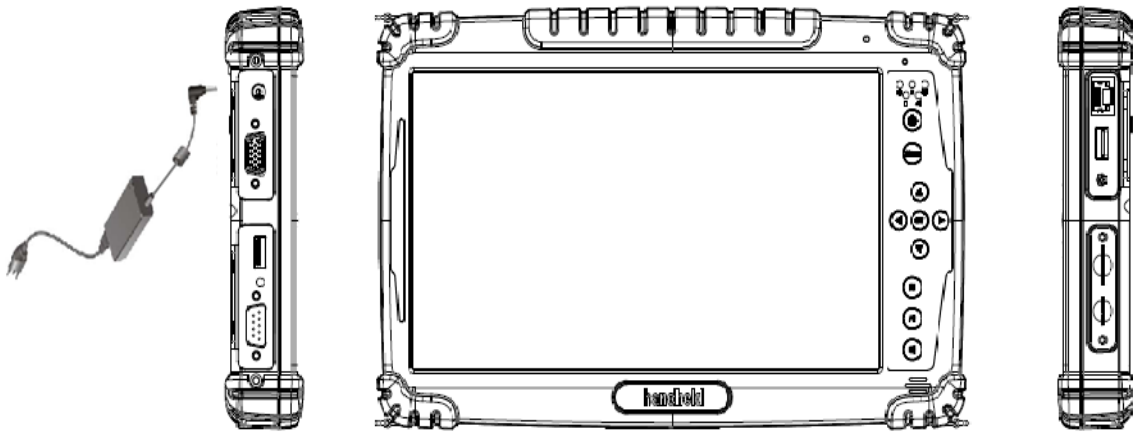

Battery Power

The ALGIZ 10X is designed to work with two types of battery. A standard battery with 5300mAh and an extended battery with double the capacity. A fully charged battery can provide up to 5 hours of run time. Among other factors, the battery life is especially dependent on the battery's condition, tablet usage, as well as the temperature.

Insertion of the Battery Pack

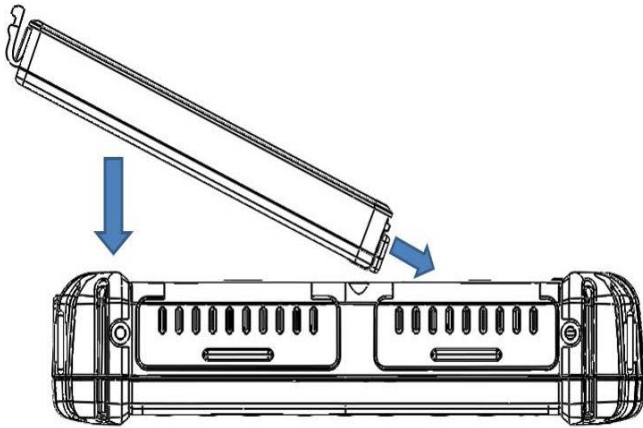

Removal of the Battery Pack

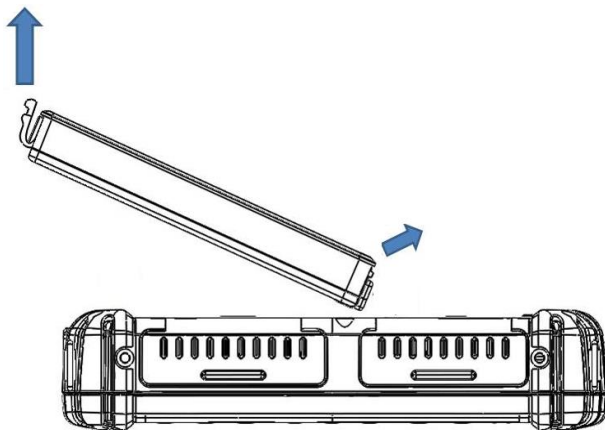

CAUTION: Please fully charge the battery in advance of operating ALGIZ 10X for the first time. New battery packs must be 100% charged before ALGIZ 10X is disconnected from the external power source. It takes a few hours to fully charge the battery when ALGIZ 10X is turned off.

Charging the Battery

Before you use your Handheld tablet PC, you need to charge the battery. The battery begins to charge as soon as the Handheld tablet PC is connected to the external power source. Please fully charge the batteries before using them for the first time. The new battery should be fully charged before the tablet PC is disconnected from the external power source. The battery pack is fully charged when the battery LED indicator turns OFF. It takes about a couple of hours to fully charge the battery when the Handheld tablet PC is turned OFF.

Battery Care

The Handheld tablet battery pack, like all rechargeable batteries, has a limit on the number of times it can be fully recharged. Fully draining and charging the battery once a day will allow the batteries to last for over a year, but rechargeable time limits are based on the ambient temperature, humidity and how your tablet PC is used. The ideal ambient temperature range is between 10°C and 29°C (50°F and 85°F).

Battery Power System

This tablet PC is designed to work with one removable battery pack placed inside the battery pack compartment. A fully charged battery pack will provide several hours of battery life, which can be extended further by configuring power management in Windows.

Charging the Battery

When the power adapter is plugged in, the battery automatically recharges regardless of whether your tablet PC is in the ON or OFF mode. It takes a couple of hours for the battery to be fully charged when the power is OFF and twice as long when the tablet PC is in use. When the charger LED indicator lights up orange, charging is required. The battery is charging when the red LED is permanently on. When the LED turns OFF, the battery pack is fully charged.

Power Supply

The power for the Handheld rugged tablet PC is supplied by the power adapter and battery pack, the power rating and manufacturer information are listed as below. For safety reasons, the adapter must be connected to ground (earth).

Power Adapter	Manufacturer: EDAC Power Electronics Co Ltd Model: EA10633B Input Rated: 100-240Vac, 1.8A, 50-60Hz. Output Rated: DC $\overline{\text{---}}$ 19V, 3.42A.
Battery Pack	Manufacturer: T-Gee Electronic Co., Ltd Model: ALG10X-08A Rated: 5300mAh DC 7.4V



CAUTION: Do not attempt to fix or replace the battery, as this may cause an explosion! Only use the specified battery and follow the instructions in the manufacturer's user manual.

Starting ALGIZ 10X

NOTE: you will be asked to enter the Microsoft Windows license number which can be found under the main battery.

Press the power button for 2 seconds to power on the ALGIZ 10X. Follow the Microsoft Windows on-screen instructions to get started with Windows. The screen calibration may not be accurate the first time you start the computer. Follow this procedure to calibrate the touchscreen:

Screen Calibration

Open Control Panel > Hardware and Sound > Tablet PC Settings

Click Calibrate and follow instructions

Repeat step 1 and 2 until you are satisfied with the calibration

Installing WWAN Module

Please read the safety precautions on page 3 before installing a WWAN module.

Insert the WWAN module into the top mini PCIe slot.

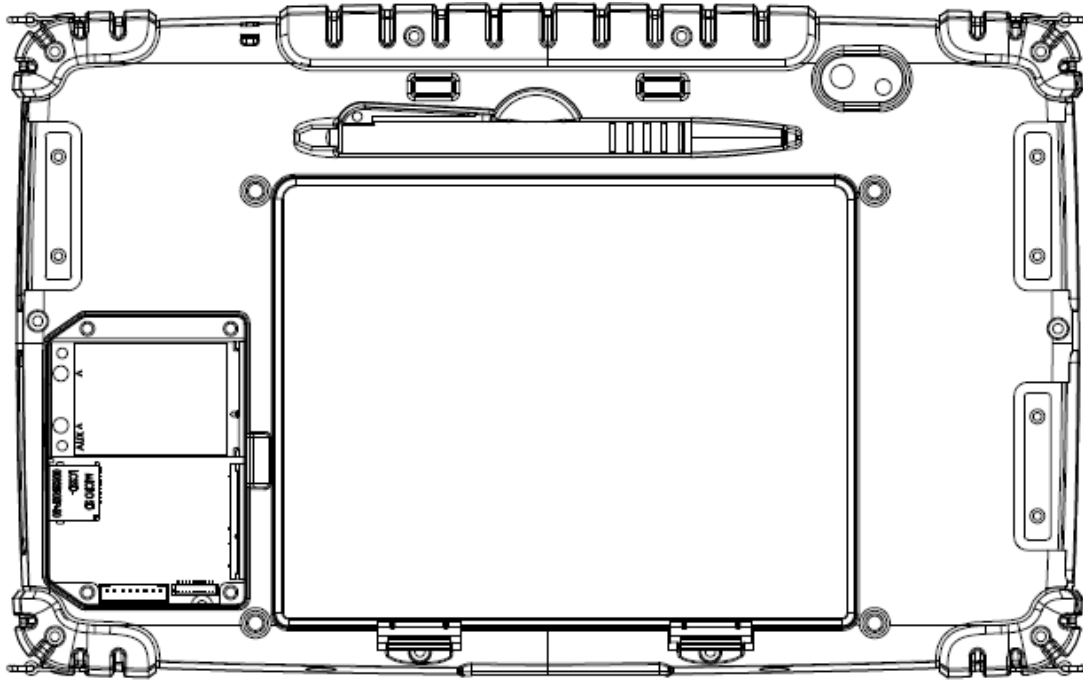

Install the antennas. The ALGIZ 10X has two WWAN antennas connected to the LTE card. Install the antennas according to the picture.



Installing SIM Card, SD Card

Remove the SIM/SD card cover on the right side. This cover is secured with two screws. Insert the SIM card according to the picture.

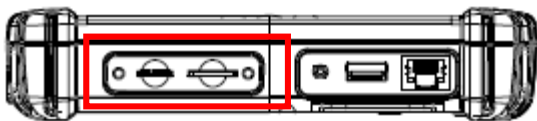

PART 3: SOFTWARE

Hot-Tab

ALGIZ 10X has a pre-installed control application, Hot-Tab. The control application is used to monitor and control features such as brightness, volume, battery status, power to modules and system information.

The control application is accessed by pressing *menu* on the ALGIZ 10X. Press *menu* multiple times to navigate through Hot-tab. You can use the arrows on the control panel to navigate within the OSD menu.

To exit Hot-Tab: Double tap outside of the Hot-Tab window or click the “x” in the top right corner.

Adjusting the LCD Brightness

The *Brightness Control* is accessed by pressing *menu* once and chooses “Setting”. Then choice and see the left and right arrow keys to adjust the LCD brightness.

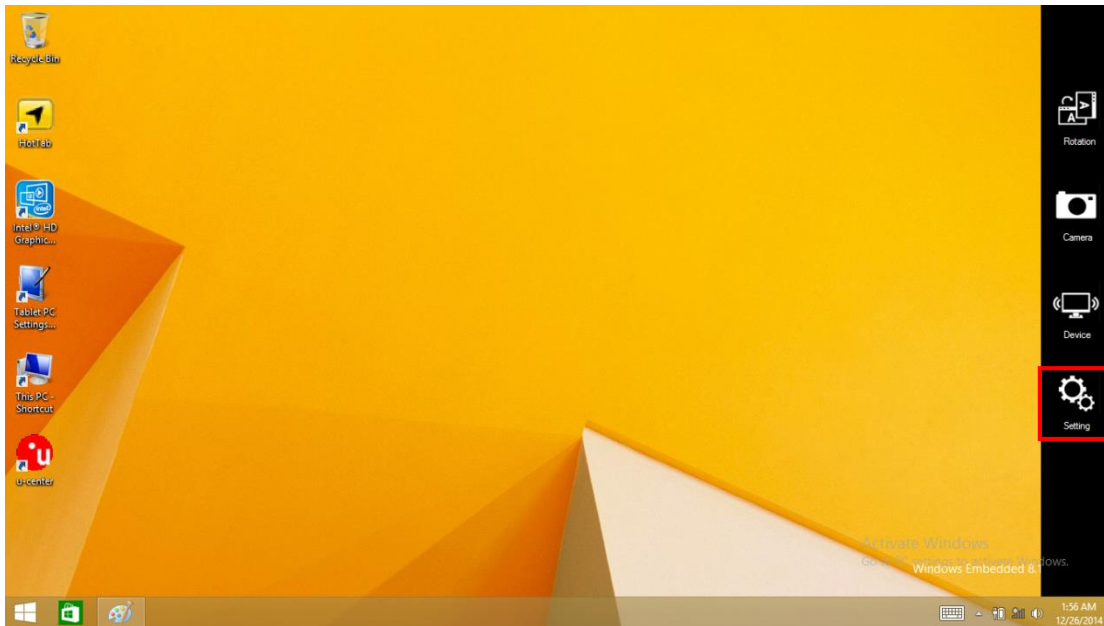

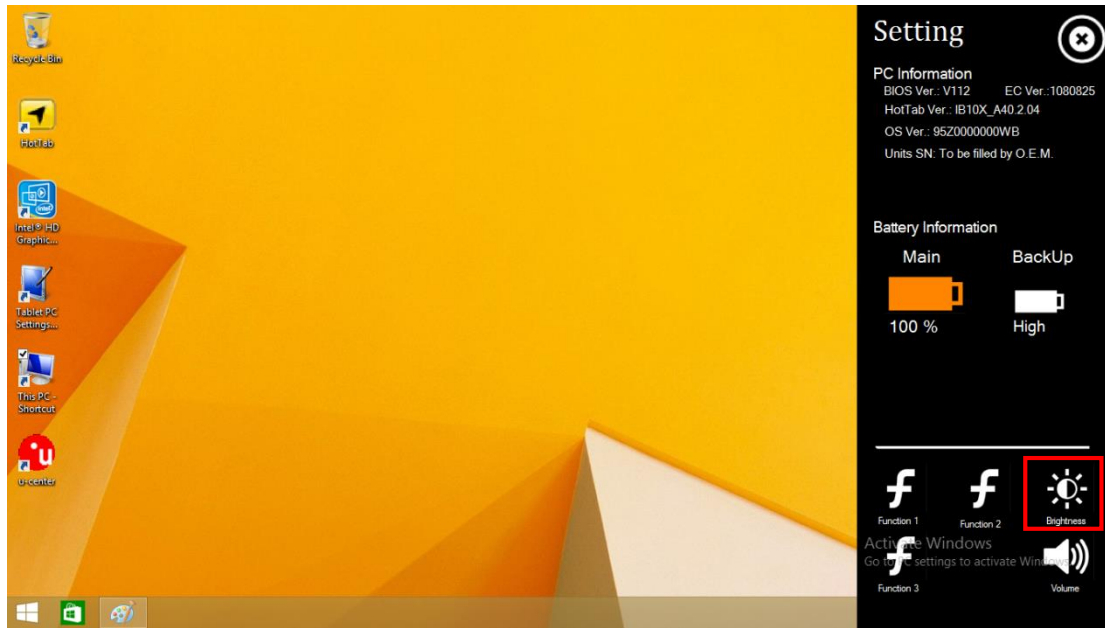

Check *Auto Brightness* to activate automatic brightness. With this item checked, ALGIZ 10X will adjust the LCD brightness based on the ambient light.

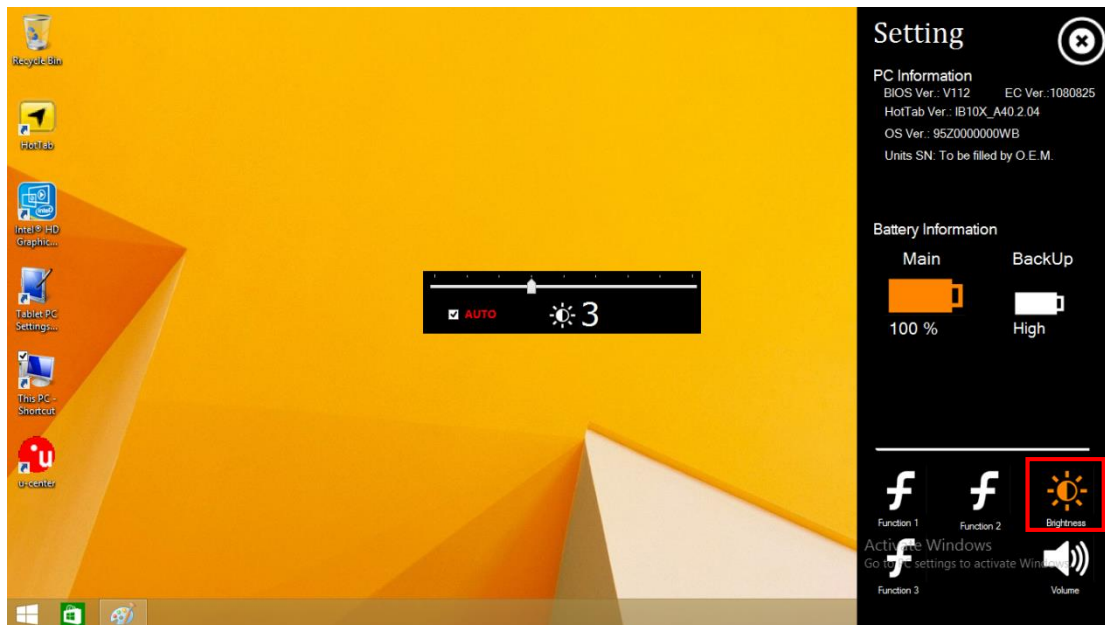

Adjusting the Speaker Volume

The *Speaker Control* is accessed by pressing *menu* once and chooses “Setting”. Then choice Use the left and right arrow keys to adjust the volume.

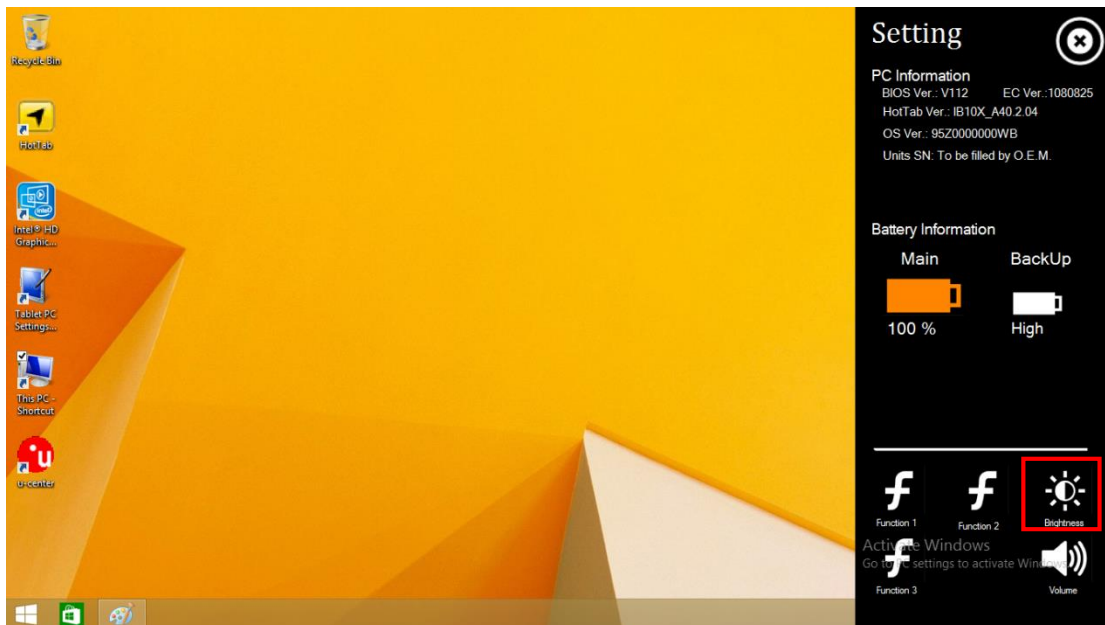

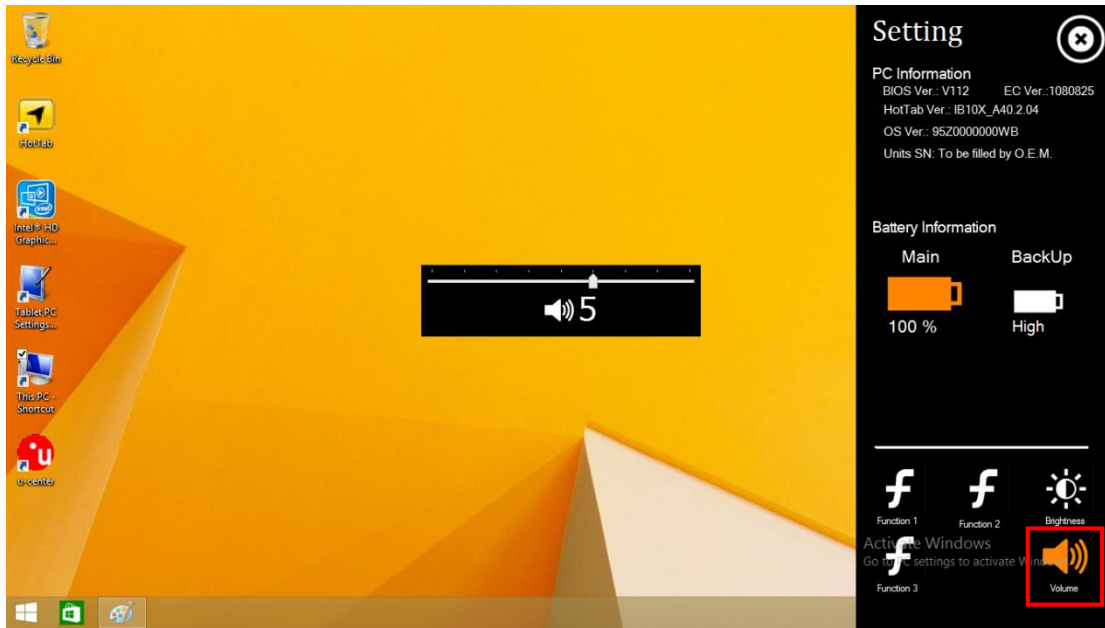

Battery Status

The *Battery status* is accessed by pressing *menu* once and chooses “Setting”.

Press the Menu button one time to view the battery status. The ALGIZ 10X has a replaceable *Main* battery as well as a *second* built-in hot-swap battery. The hot-swap battery will activate once the main battery is empty or unplugged.

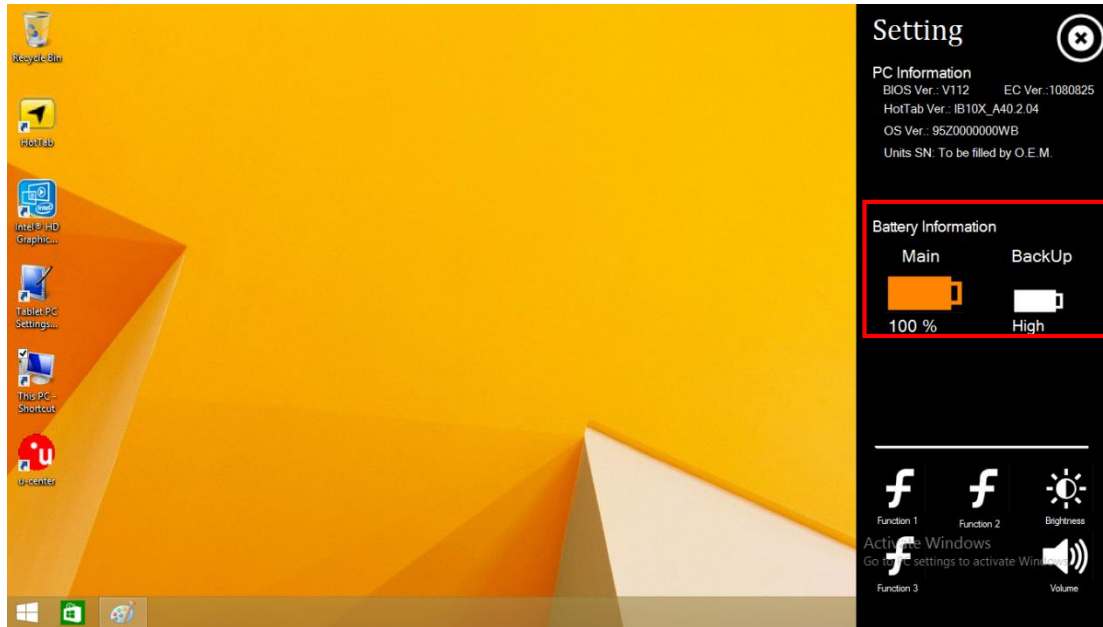

WLAN

ALGIZ 10X can connect to IEEE 802.11 ac a/b/g/n networks operating on 5GHz.

The *Function Control* is accessed by pressing *menu* one time and chooses “Device”. Check *Wi-Fi* to turn the Wi-Fi radio on. Uncheck *Wi-Fi* to turn it off.

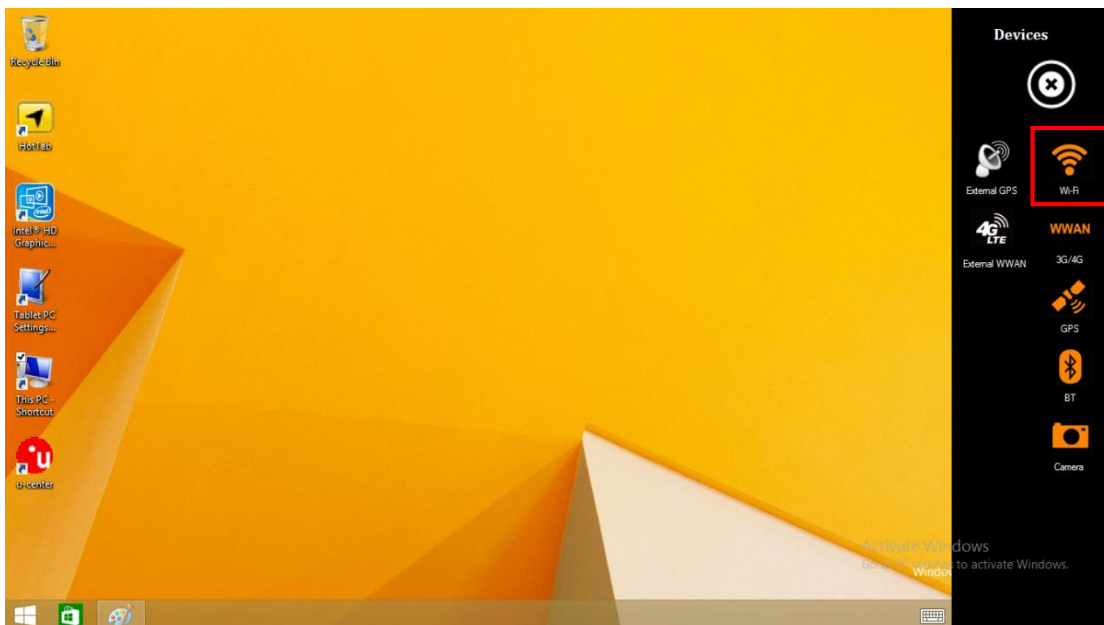

Bluetooth

Depending on your application, the Bluetooth module can give you capability for short-range wireless communication between devices without requiring a cable connection. The transmission can pass through walls, pockets and briefcases as long as the two devices are within a range of around 10 meters.

The *Function Control* is accessed by pressing *menu* one time and chooses "Device". Check *Bluetooth* to turn the Bluetooth radio on. Uncheck *Bluetooth* to turn it off.

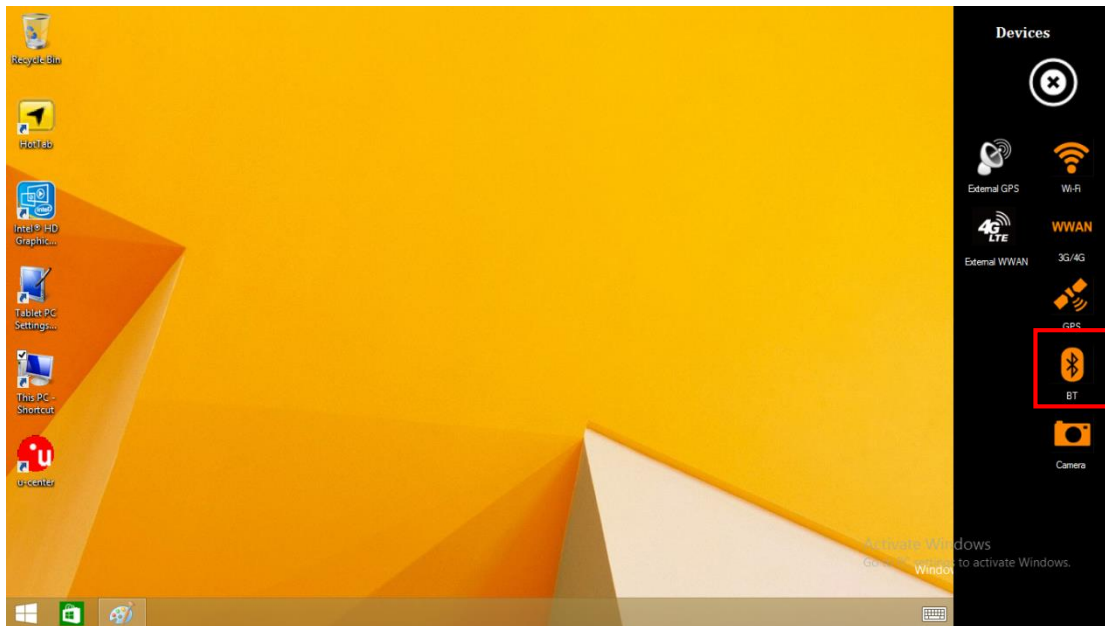

WWAN (LTE) - Optional

The ALGIZ 10X is prepared for WWAN (LTE) connectivity. If you have a WWAN modem installed, the navigate to the *WWAN* by pressing *menu* one time and chooses “Device. Check *LTE* to switch WWAN radio on/off.

Note: You must install a SIM card in order for the ALGIZ 10X to access a WWAN network.

To open the WWAN control program, double click *Windows connection manager* on the desktop. Press *Connect* to connect to a WWAN network.

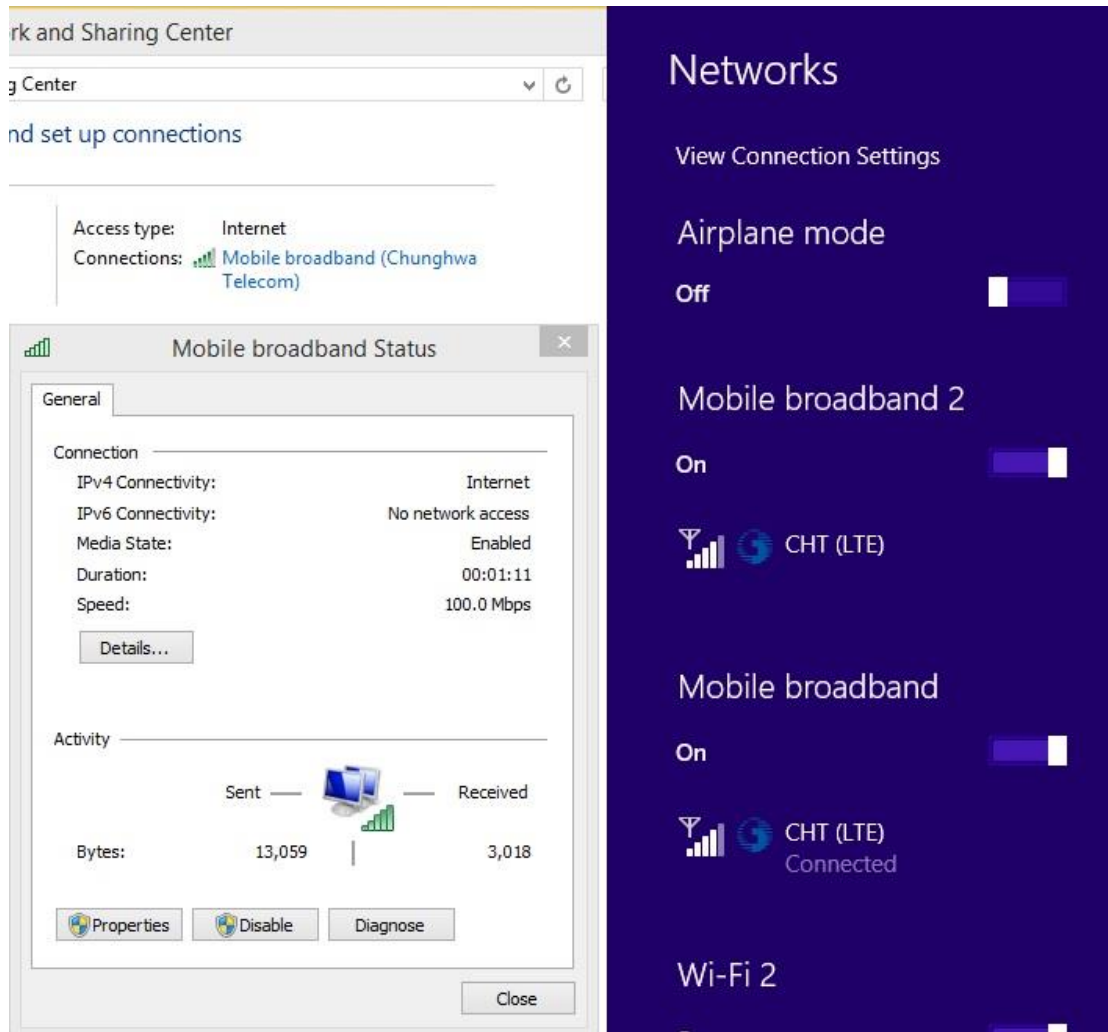

GPS

ALGIZ 10X is equipped with a dedicated GPS receiver for optimum performance.

The *Function Control* is accessed by pressing *menu* one time and chooses “Device”. Check *GPS* to turn the GPS receiver on. Uncheck *GPS* to turn it off.

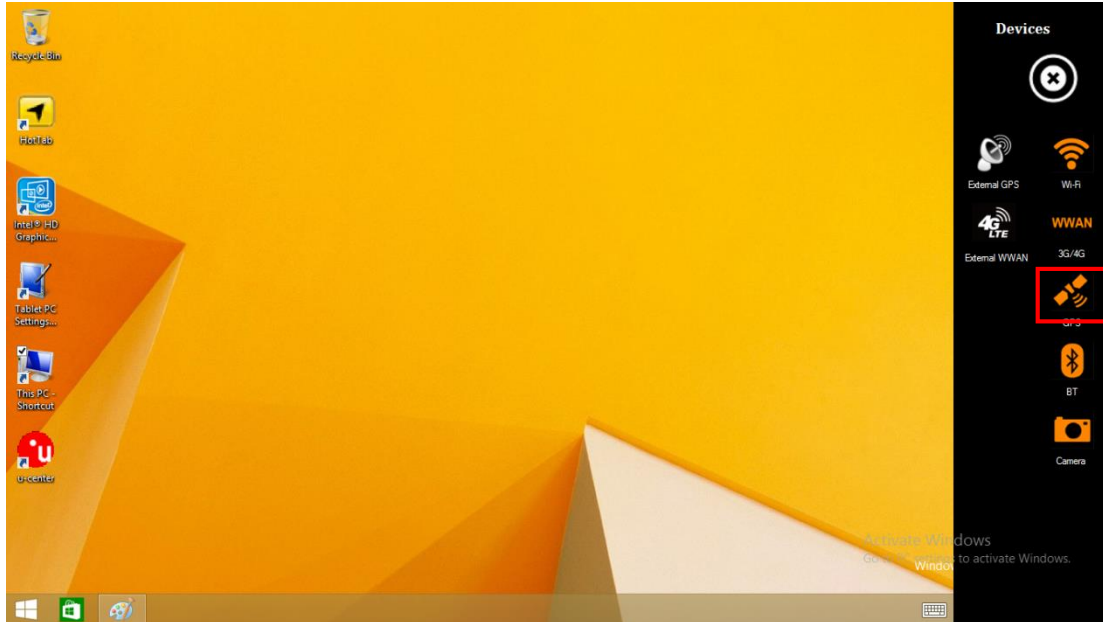

The GPS evaluation software, U-Center, is accessed by double-clicking the *U-Center icon* available on the desktop.

Set the *port* to COM3

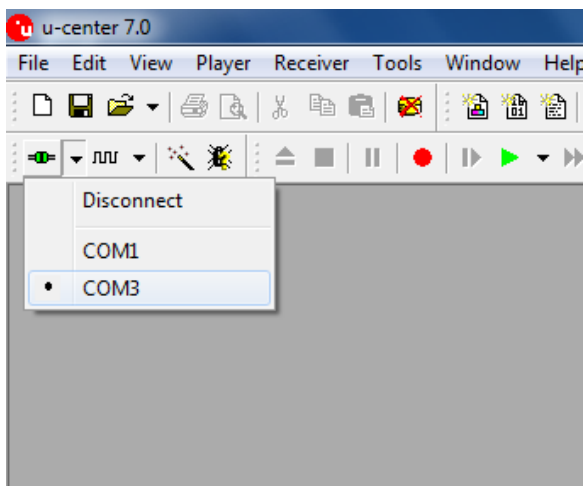

Set *Baud rate* to 9600

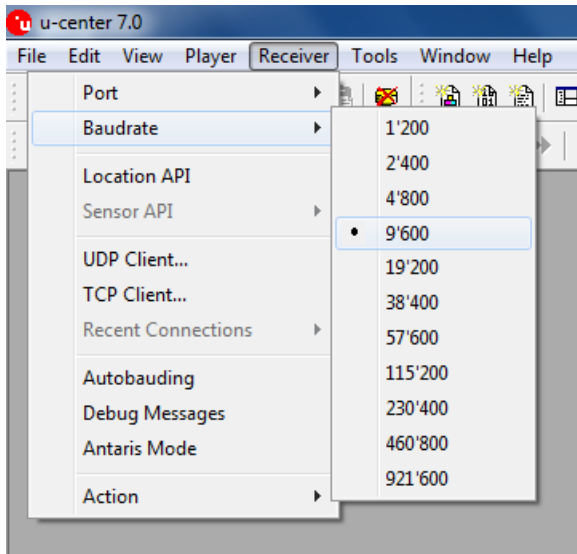

GPS will now start looking for satellites to calculate its position. This procedure may take from a few seconds to a few minutes depending on satellite positions, interference, environmental factors and radio noise.

Tip: See the U-Center manual for more information about this GPS evaluation software.

Camera

The ALGIZ 10X has a built-in 5-megapixel camera.

The *Function Control* is accessed by pressing *menu* one time and chooses "Device". Check *Camera* to turn the Camera on. Uncheck *Camera* to turn it off.



Or press menu and click the Camera icon to start the Camera.

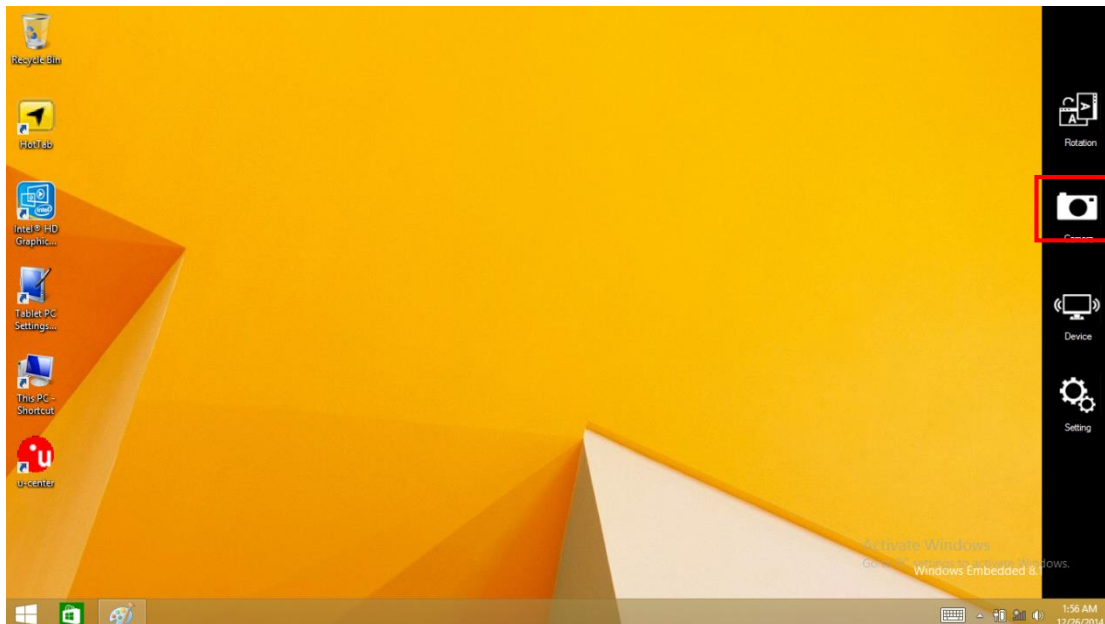

In the  settings you can control the destination folder for saved pictures or videos, previews, as well as image resolution.

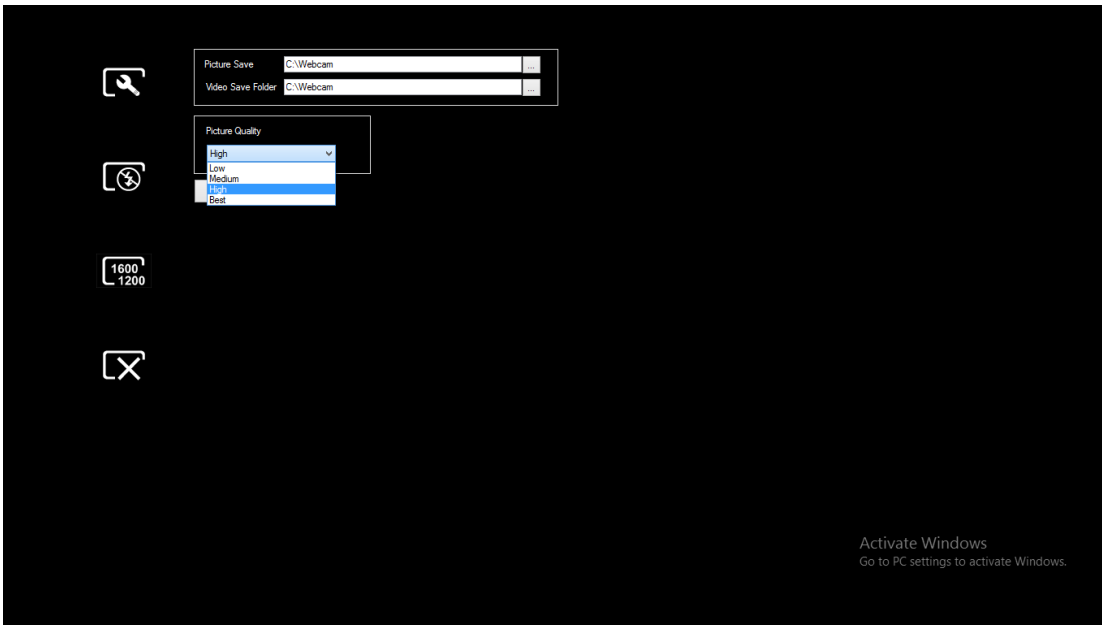

In the  settings you can control the flash light mode to on/off/auto.



In the  settings you can control the image resolution.



In the  settings you can switch to photograph or video mode.



In the  settings you can take a picture.



External GPS Antenna

The *Function Control* is accessed by pressing *menu* one time and access to “Device”. Check *External Antenna (auto)* to activate an external antenna installed on the vehicle dock **Alg10X-05A**. When this item is checked, Alg10X will automatically switch to the external antenna when the unit is docked. Do not check this item unless you have an external antenna installed on your Alg10X-05A vehicle dock. Uncheck *External GPS (auto)* to turn this feature off.

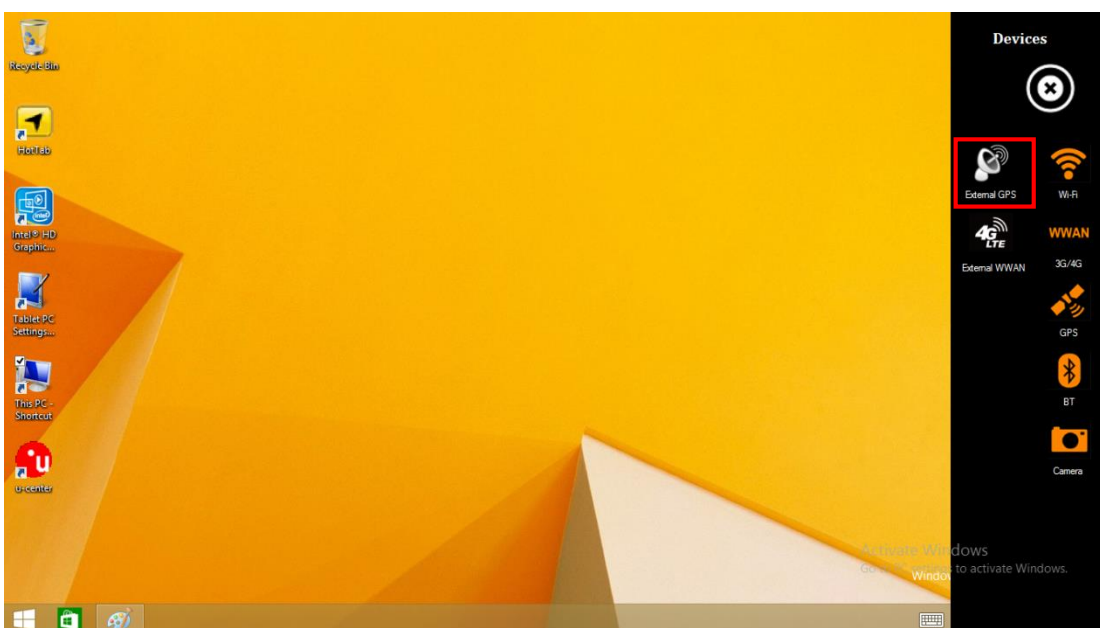

External WWAN Antenna

The *Function Control* is accessed by pressing *menu* one4 time and access to “Device”. Check *External WWAN (auto)* to activate an external antenna installed on the vehicle dock **Alg10X-05A**. When this item is checked, Alg10X will automatically switch to the external antenna when the unit is docked.

Do not check this item unless you have an external antenna installed on your Alg10X-05A vehicle dock. Uncheck *External WWAN (auto)* to turn this feature off.



System Information

Press the Menu button one time and access to "Setting" to view system information. Please have this information ready if you are contacting Handheld support.

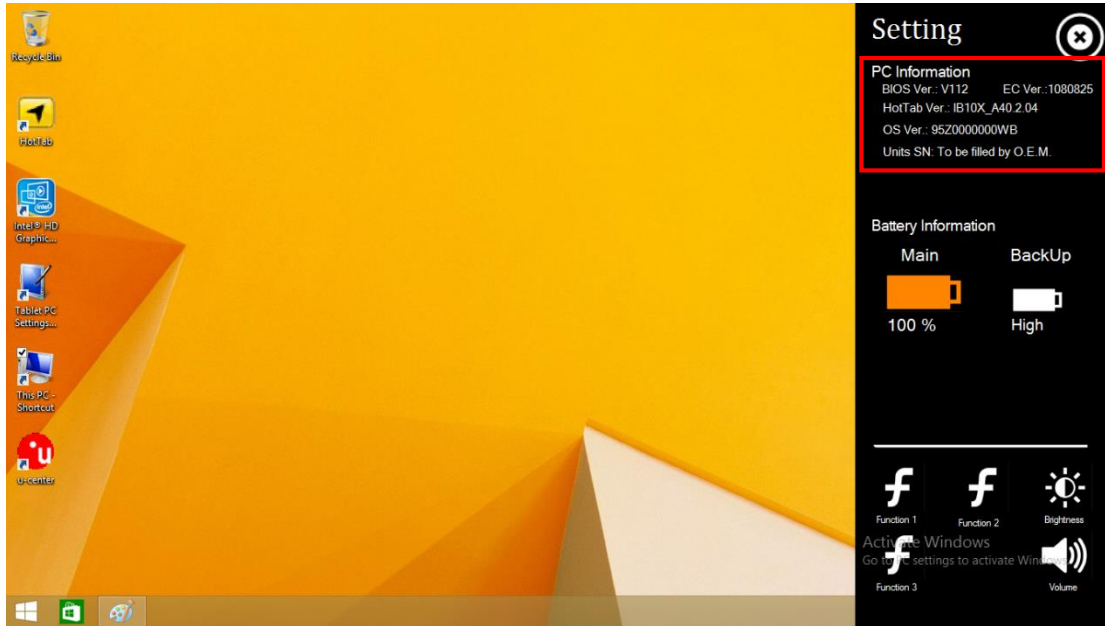

PART 4:

REGULATORY INFORMATION

FCC Compliance Statement

This device complies with Part 15 of the FCC Rules. Operation is subject to the following two conditions:

1. This device must not cause harmful interference, and
2. This device must be able to withstand any interference received, including interference that may cause undesired operation.

FCC Warning

This equipment has been tested and found to comply with the limits for a Class B digital device, pursuant to Part 15 of the FCC Rules. These limits are designed to provide reasonable protection against harmful interference in a residential installation. This equipment generates, uses and can radiate radio frequency energy and, if not installed and used in accordance with the instructions, may cause harmful interference to radio communications. However, there is no guarantee that interference will not occur in a particular installation. If this equipment does cause harmful interference to radio or television reception, which can be determined by turning the equipment off and on, the user is encouraged to try to correct the interference by one or more of the following measures:

- Reorienting or relocating the receiving antenna.

Increasing the distance between the equipment and the receiver.

- Connecting the equipment to a different outlet from that to which the receiver is connected.
- Consulting the dealer or an experienced radio/TV technician for help.

Caution:

To comply with the limits for an FCC Class B computing device, always use the shielded signal cord supplied with this unit. The Federal Communications Commission warns that changes or modifications to the unit not expressly approved by the party responsible for compliance could invalidate the user's authority to operate the equipment.

FCC RF Radiation Exposure

This equipment complies with the FCC RF radiation exposure limits stipulated for an uncontrolled environment. This device and its antenna must not be co-located or operated in conjunction with any other antennas or transmitters. To comply with FCC RF exposure compliance requirements, the antenna used for this transmitter must be installed so as to provide a separation distance of at least 20 cm from all persons and must not be co-located or operated in conjunction with any other antennas or transmitters.

PART: 5
ALGIZ 10X CARE

Battery Protection Tips

The recommended temperature range for charging the battery pack is -5°C ~ 35 °C.

To avoid damage to the battery, recharge the battery pack when it is nearly discharged. When recharging, the battery pack should be fully charged.

The battery pack is a consumable product and the following factors will shorten its life:

- Frequently charging the battery pack
- Using, charging or storing the battery at high temperatures

A high ambient temperature will cause the temperature of the battery pack to rise. Avoid charging the battery pack inside a closed vehicle and in hot weather conditions. Charging will also not start if the battery pack is not within the allowed temperature range.

Charging the battery pack with the system's power off is recommended.

To maintain the battery pack's operating efficiency, store it in a cool dark place removed from the tablet PC and with 30 % ~ 40 % charge remaining.

Avoid installing or removing the battery pack when the ALGIZ 10X is in Standby mode.

Charging time will be prolonged when the ALGIZ 10X is turned on.

- No debris, combustibles or chemicals should be allowed near the battery while charging. Extra caution is required when charging the battery in non-commercial conditions.
- The battery should only be used in accordance with the instructions for use, storage and recharging as set out by this manual.
- Improper use of the battery may result in fire or explosion.
- Do not use incompatible batteries or chargers. The use of incompatible batteries or chargers may result in risks such as fire, explosion, leaks, etc. If you have any questions about batteries or the charger, contact Handheld.
- Do not attempt to disassemble, open, bend, modify, puncture or smash the product or the battery.
- If you drop the device hard on a solid surface, the battery may overheat.
- Extra care must be taken to avoid short circuiting, connect a metal conductor to the battery terminals.
- Special attention must be paid to avoid modification, resetting, inserting foreign bodies into the battery, exposing the battery to water or other liquids, fire, explosion and other risks.
- Do not allow children to handle the battery unsupervised.
- Used batteries must be disposed of in accordance with local regulations.
- Do not burn the battery.
- If the battery has been swallowed, immediately contact a doctor.
- If the battery leaks, be careful not to allow the fluid to come into contact with skin or eyes. If battery fluid comes into contact with skin or eyes, rinse using plenty of water and seek immediate medical advice.
- If you suspect damage to the device or the battery, contact Handheld.

Touch Screen Protection Tips

Avoid applying excessive force to the display, use only your finger or the supplied touchscreen stylus pen on the display. The recommended force shall not exceed 200gf.

Take care to protect the screen from scratches. Only use a plastic pen designed for touchscreens or the stylus provided. Never use pens, pencils or other sharp objects on the screen.

To clean the touchscreen, wipe the screen with a clean, soft, lint-free cloth.

It is recommended that the screen is protected using protective film (one sheet of protective film is supplied with the product). Advantages of using protective film include the following:

Protects the screen from scratches and grooves.

More realistic feel when writing and touching

Protects the screen from damage caused by abrasion and foreign bodies.

Extends the lifespan of the touchscreen.

Your Handheld product screen is made from glass. Do not apply excessive force to the screen.

Using the touchscreen at low temperatures (less than 5 °C) may cause a slower response time, which is normal. A normal response time will be restored once the unit returns to room temperature.

Use only detergents or cleaners intended for computers. Take care not to allow any excess liquid to enter the gaps around the screen. To avoid scratches, wipe using a dry non-abrasive cloth.

ALGIZ 10X Care

Protect your Handheld product from extreme temperature changes. When the temperature is high, do not leave the device on the dashboard of a vehicle and keep well away from any heat sources.

Do not use or store your Handheld product in dirty, humid or wet conditions that are beyond the product specifications.

To maximize battery life and performance, replace the battery periodically. The battery life depends on its use.

Cleaning the Exterior

Use only detergents or cleaners intended for computers.

Connectors

1. Remove the battery
2. Soak the end of a swab with isopropyl alcohol and rub across the connector pins.
3. Be careful not to leave any residue on the connectors.
4. This process should be repeated approximately three times.

NOTE: If isopropyl alcohol is not available, use computer cleaning detergent or a pencil eraser (rubber), taking care not to leave any foreign bodies on the pins.

Copyright Notice

Copyright © 2010 Handheld Group AB, ALL RIGHTS RESERVED. No part of this document may be reproduced, copied, translated or transmitted in any form or by any means, electronic or mechanical, for any purpose, without the prior written permission of the original manufacturer.

Trademark Acknowledgement

Brand and product names are trademarks or registered trademarks of their respective owners.

Disclaimer

Handheld Group AB reserves the right to make any product changes without notice, including to circuits and/or software described or contained in this manual, in order to improve design and/or performance. Handheld Group AB assumes no responsibility or liability for the use of the described product(s), conveys no license or title under any patent, copyright, or mask works rights to these products and makes no representations or warranties that these products are free from patent, copyright, or mask works rights infringement, unless otherwise specified. Applications described in this manual are for illustration purposes only. Handheld Group AB makes no representation or warranty that such applications will be suitable for the specified use without further testing or modification.

Customer Service

Support is provided by Handheld. Visit our website at www.handheldgroup.com to find updated information about the product. You can also contact your distributor, sales representative or our customer support center for further assistance. If you contact our customer support center please have the following information ready before you call:

Product serial number

Peripheral attachments

Software (OS, version, application software, etc.)

Description of complete problem

The exact wording of any error messages with print screen images

In addition to this, free technical support is available from our engineers during working hours. We are always ready to provide advice on application requirements or specific information about the installation and operation of any of our products. Please do not hesitate to call or e-mail us.

Manufacturer: Handheld Group AB

Address: Handheld Group AB, Kinnegatan 17 A, SE-531 33, Lidköping, Sweden

TEL: +46 (0) 510-54 71 70 FAX: +46 (0) 510-282 05