

DEESEA
Power & Light®



LED SeaLite®



Operator's Manual

T: (858) 576-1261
F: (858) 576-0219

4033 Ruffin Road
San Diego, CA
92123- 1817 USA

www.deepsea.com
sales@deepsea.com



Specification Overview

	LSL-1000	LSL-2000	LSL-2025
Optical Specifications			
Typical Lumen Output (Flood)	10,000		See www.deeppsea.com/multiray for sample configuration specifications.
Efficacy	63 lm/w ¹	94 lm/w ¹	
Lux at 1 m	Wide ² : 2,300 lx Flood: 5,600 lx Spot: 14,000 lx		
Color	Day Light White 5000 K ~ 6500 K Warm White 2600 K ~ 3700 K Contact Sales for Color Options		
CRI	Day Light White: 70 Warm White: 80		
Beam Angle (HPFW)	Wide ² : 115° Flood: 75° Spot: 35°		
Environmental Specifications			
Depth Rating	4,000 m Acrylic Port 6,000 m or 11,000 m Sapphire Port		
Thermal Protection	Intelligent Thermal Rollback		
Operational Temperature	-10°C to 40°C [14°F to 104°F] ³		
Storage Temperature	-40°C to 100°C [-40°F to 212°F]		
Electrical Specifications			
Voltage	90~140 VAC 50/60 Hz 110~160 VDC	10~48 VDC ¹	
Power	160W @ 120 VAC 60 Hz	106W @ 24 VDC	
Dimming	RS232 ⁴ , RS485 ⁴ , Phase/Triac	RS232 ⁴ , RS485 ⁴ , 0~5V, 0~10V, 4~20mA	
Mechanical Specifications			
Housing	Hard Anodized 6013 Aluminum Titanium		
Port	Standard: Sapphire Optional: Acrylic		
Outer Diameter	63.0 mm [2.48 in]		
Overall Length (Without Connector)	Acrylic Flood/Wide: 95.9 mm [3.77 in] Sapphire Flood: 93.3 mm [3.67 in] Acrylic/Sapphire Spot: 99.6 mm [3.92 in]		
Weight in Air⁵	Sapphire Flood: 490 g Sapphire Spot: 510 g	Sapphire Flood: 450 g Sapphire Spot: 470 g	
Weight in Water⁵	Sapphire Flood: 240 g Sapphire Spot: 260 g	Sapphire Flood: 200 g Sapphire Spot: 220 g	
Connector⁶			
Default	SEACON MCBHMP SS Please contact sales for more options.		

¹ 100% output available above 20 VDC. 50% output from 10~20 VDC due to input current limits.

² Wide beam angle only available on Acrylic port 4,000 m depth rating.

³ For 120 VAC versions, thermal rollback may reduce light output in water temperatures exceeding 25° C [77° F]. See Manual for additional information.

⁴ For RS232 and RS485, see Manual.

⁵ Nominal values are measured with MCBHMP connector and aluminum housing.

⁶ Ensure that ampacity ratings for interconnect system are suitable for your operating conditions. See Manual for more information.

Specification Overview

Dimensions

Flood Beam Acrylic Port

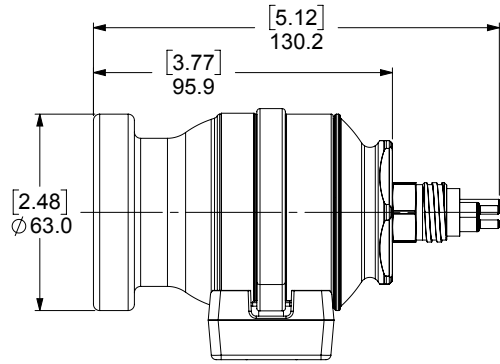

FLOOD/WIDE ACRYLIC ALUMINUM
mm [inch]

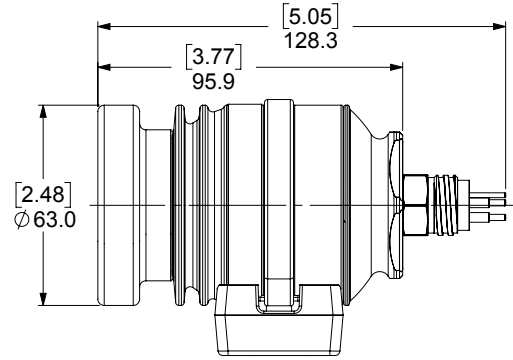

FLOOD/WIDE ACRYLIC TITANIUM
mm [inch]

Flood Beam Sapphire Port

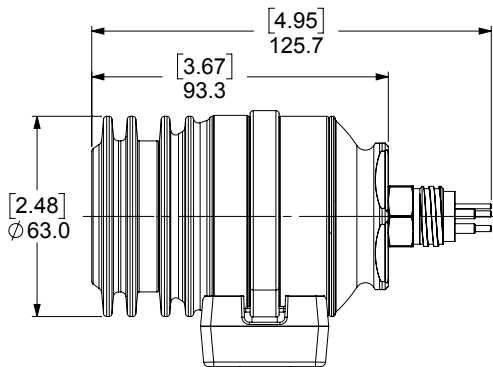

FLOOD SAPPHIRE
mm [inch]

Spot Beam

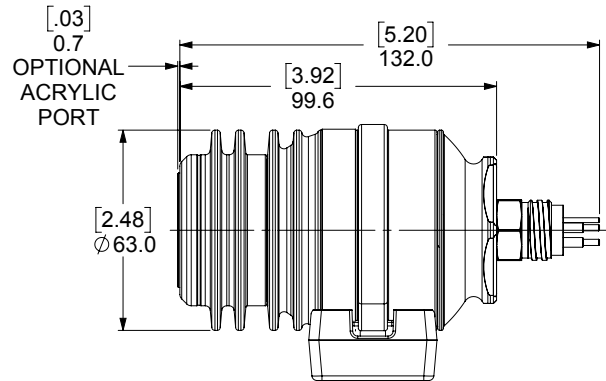

SPOT ACRYLIC/SAPPHIRE
mm [inch]

Bracket

SADDLE BRACKET

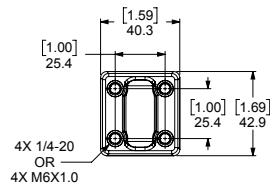
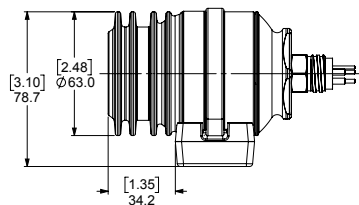

mm [inch]

COLLAR BRACKET

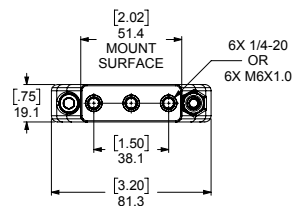
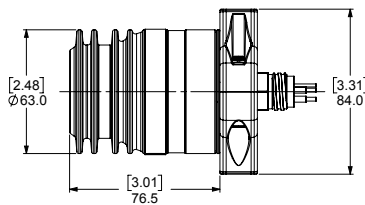

Table of Contents

Specification Overview	2-3
Table of Contents.....	4
General Notes & Warnings.....	5
Pre & Post Dive Inspection	6
Troubleshooting.....	6
RMA Procedure for Repair.....	6
Limited Warranty	6
Appendix A LSL-1000 Driver Characteristics	7-8
Appendix B LSL-2000 Driver Characteristics	9
Appendix C Dimming Curve.....	10-12
Appendix D Beam Patterns	13
Appendix E SeaSense™ Information	14
Appendix F USB Interface Driver Installation	15-20

Safety Symbols

In this operator's manual and on the product, safety symbols are used to communicate important safety information. This section is provided to improve understanding of these symbols.



This is the safety alert symbol. It is used to alert you to potential personal injury hazards. Obey all safety messages that follow this symbol to avoid possible injury or death.



DANGER indicates a hazardous situation which, if not avoided, could result in death or serious injury.



WARNING indicates a hazardous situation which, if not avoided, could result in damage to the product or bodily harm.



CAUTION indicates a hazardous situation which, if not avoided, could result in minor or moderate injury.



NOTICE indicates information that relates to the protection of property.



This symbol means read the operator's manual carefully before using the equipment. The operator's manual contains important information on the safe and proper operation of the equipment.



This symbol means always wear safety glasses with side shields or goggles when handling or using this equipment to reduce the risk of eye injury.



This symbol indicates the risk of electrical shock.



This symbol indicates a risk of exposure to high brightness.



UV and blue light can cause eye injury. Avoid exposure to eyes.



This symbol indicates high voltage.



This symbol indicates a potentially hot surface that may cause burns or ignition.

General Notes & Warnings

The LED SeaLite® light is designed and built for years of reliable service.

This light was thoroughly pressure tested prior to leaving the factory to confirm the integrity of the complete assembly. While there should be no reason to repair the LED SeaLite, this light is designed to be completely field serviceable. No soldered wire connections or specialized tools are required. All o-rings use viton material and have an extended shelf life.

The LED SeaLite can run at full power in air. This light is equipped with thermal sensing circuitry which will automatically roll back the light output and prevent it from overheating. The light will return to full brightness once it is submerged and allowed to cool.



Modifying the light in any way may damage the light and void the warranty.

Do not clean any part of the light with solvent or alcohol. Soapy water is recommended.

Reconfiguring the pin-out of the light is potentially dangerous to the operator and can cause significant damage to the light. Any change to the pin-out should be done only through consultation with the factory in order to provide proper documentation and new pin-out labeling. Failure to do so will result in the loss of warranty coverage for the light.



When the LED SeaLite is operated in air, the light may reach temperatures in excess of 65° C (150° F). These temperatures may cause burns if the light is handled without personal protective equipment.

While operating in air, this light emits sufficient photonic energy to ignite combustible materials. When light is operating in air, take appropriate precautions.

Do not operate any high voltage electrical equipment in or around water without using proper safety equipment such as a Ground Fault Circuit Interrupter (GFCI) and an isolation transformer, especially when divers are in the water.

Pre & Post Dive Inspection

Check to make sure that the rear bulkhead connector, mating connector, and all mounting hardware are secure before deployment.

Check the following areas for previous damage, wear, or corrosion: rear bulkhead connector, power cable, and front port.

Rinse the LED SeaLite in fresh water after use. After each deployment, carefully check to make sure the light is operational and has not flooded. If it has flooded, the light can become internally pressurized upon surfacing and create a potential danger. Additionally, if the power remains on when the light has partially flooded, it is possible for electrolytic generation of an explosive mixture of hydrogen and oxygen gases. Point the light away from persons and valuable equipment and make sure that the power is disconnected.

Troubleshooting

If the light stops working while underwater, assume that it has flooded.

If it has been determined that the light is not flooded, and if the light does not turn on during pre-deployment checks, check the input power cable/inline connector to make sure that correct voltage is being supplied and that the correct pin-out is being used. If the light still does not work, return it to DSPL using the RMA Procedure for Repair below.

RMA Procedure for Repair

For warranty and non-warranty repairs, please contact DeepSea Power & Light for an RMA number prior to returning the item. Please have the light model number, serial number, and any other pertinent information along with a description of the problem on hand when calling, or include them in a fax or e-mail.

When shipping the item, be sure that the freight is pre-paid (CODs will not be accepted) and that the RMA number is clearly printed on the outside of the box.

All shipments should be sent to the address below:

DeepSea Power & Light
Attn: RMA #####
4033 Ruffin Road
San Diego, CA 92123-1817
U.S.A
Tel: 858-576-1261

Fax: 858-576-0219
Email: RMA@deepsea.com

Limited Warranty

Seller warrants that the goods (except internal electronic components) sold under this contract will be free from defect in material and workmanship for a period of two years from the date of shipment from the factory, if they have been properly used. Internal electronic components are warranted for 90 days from the date of shipment from the factory, if they have been properly used. This warranty will be limited to the repair or replacement of parts and the necessary labor and services required to repair the goods. IT IS EXPRESSLY AGREED THAT THIS WARRANTY WILL BE IN LIEU OF ALL WARRANTIES OF FITNESS AND IN LIEU OF THE WARRANTY OF MERCHANTABILITY. This warranty is the exclusive and only warranty to pass with the goods under this contract. No agent, employee, or representative of the Seller has any authority to bind Seller to any information, representation, or warranty concerning the goods sold under this contract, and unless an affirmation, representation, or warranty made by an agent, employee, or representative is specifically included within this contract, it will not be enforceable by Buyer. If notice of defect is given to DeepSea Power & Light LLC within such 90 day or two-year warranty period, the sole obligation of DeepSea Power & Light LLC shall be to furnish new or repaired parts free of charge in exchange for parts which have been proved defective and does not include any other costs such as the cost of removal of the defective part, installation, labor, or consequential damages of any kind, the exclusive remedy being to require DeepSea Power & Light LLC to furnish such new parts. Under no circumstances shall the Buyer be entitled to recover any incidental damages as that term is defined in Commercial Code §2715.



T: 800-487-3775
F: 858-576-0219

www.deepsea.com
sales@deepsea.com



Appendix A

LSL-1000 Driver Characteristics

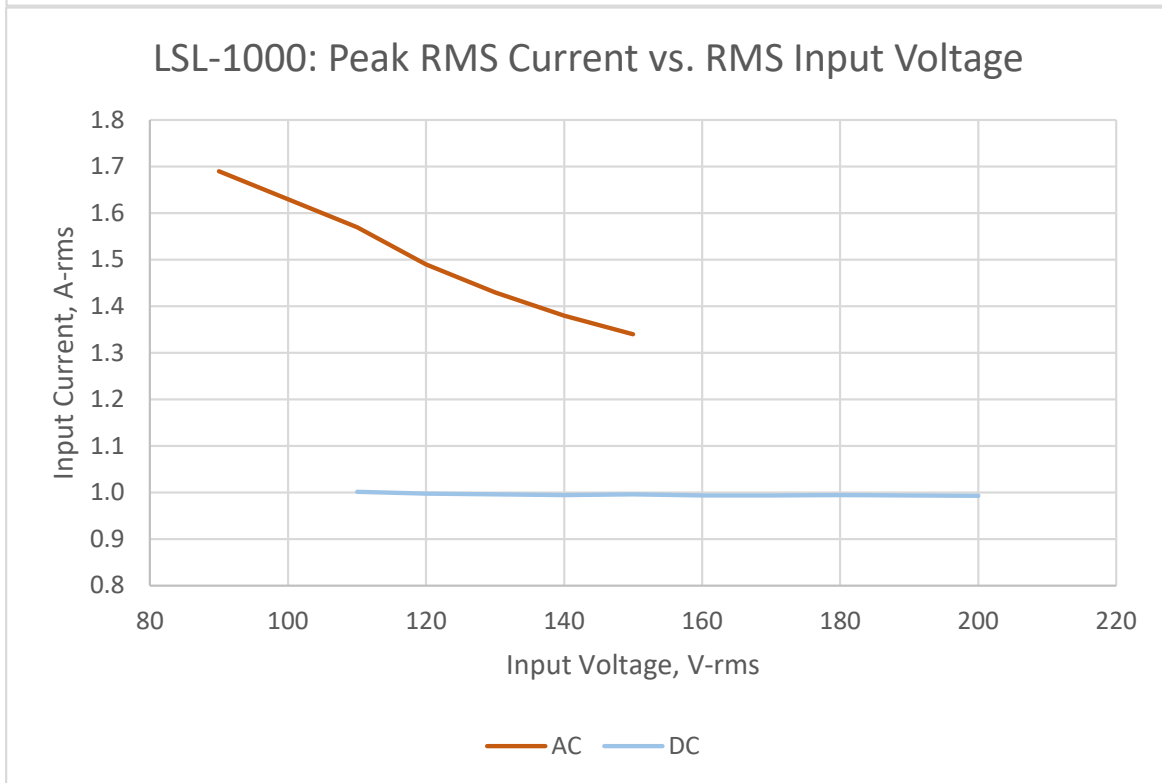
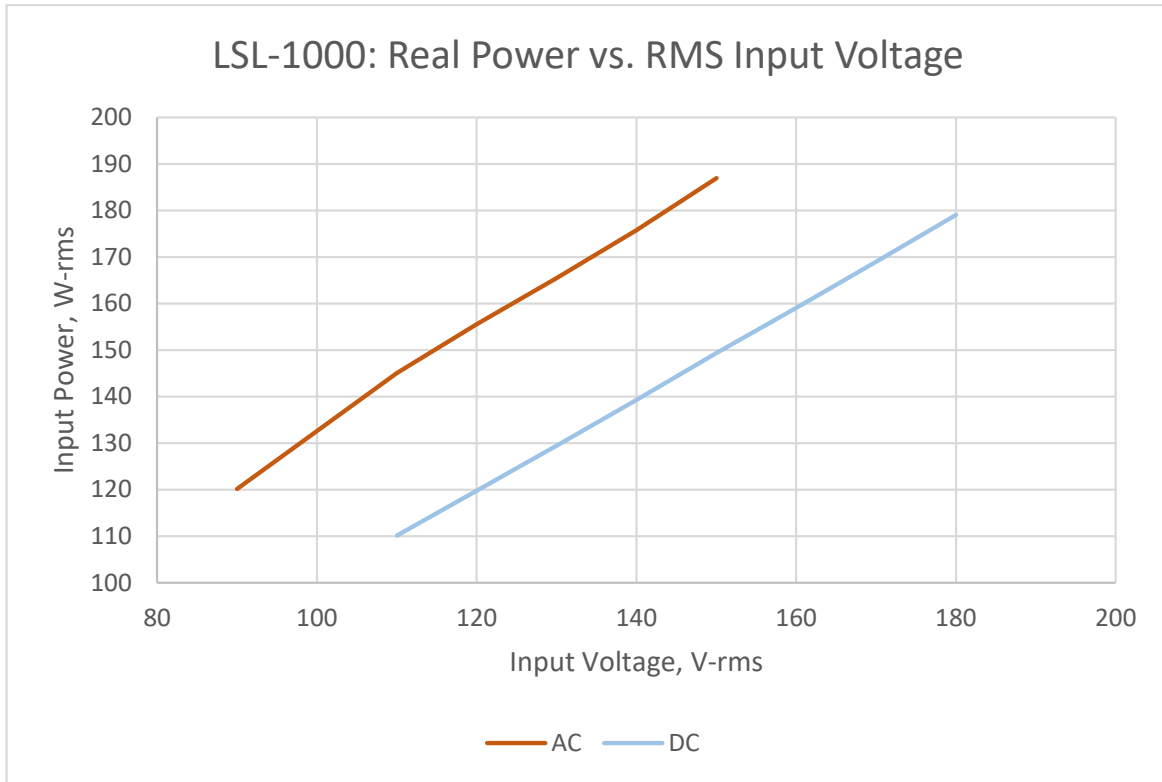

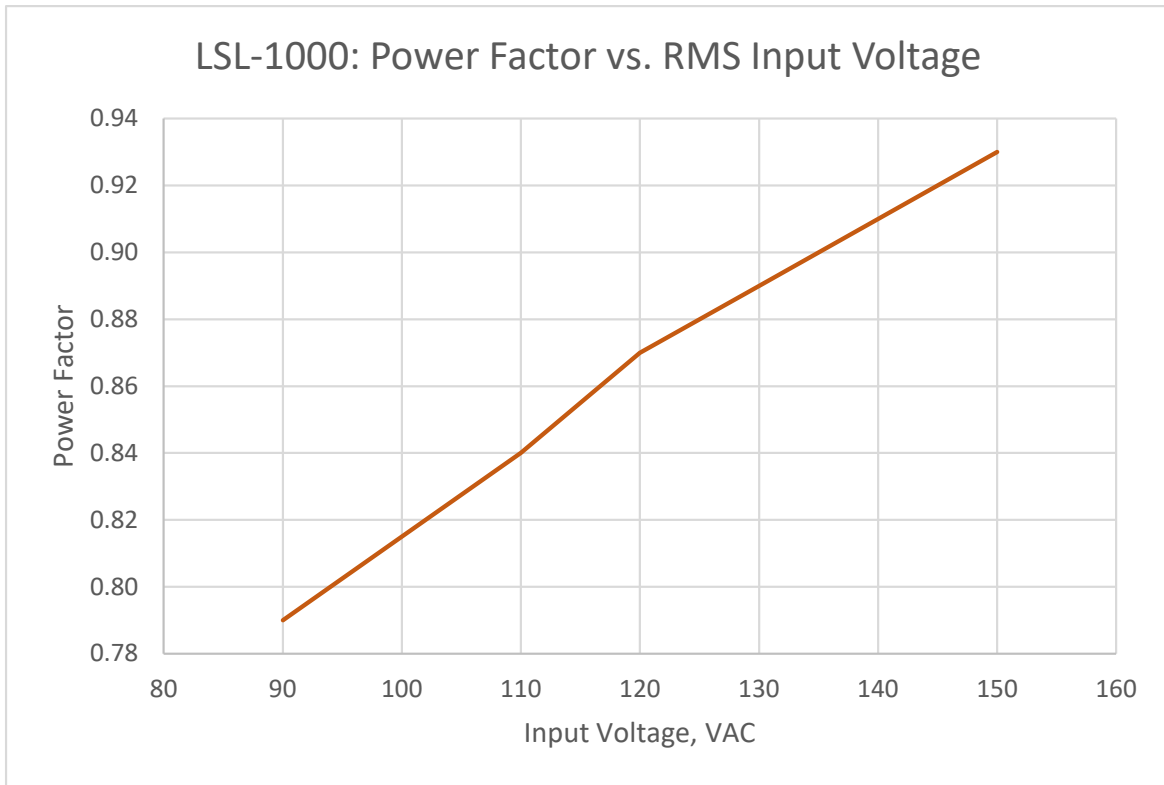

Appendix B

LSL-2000 Driver Characteristics

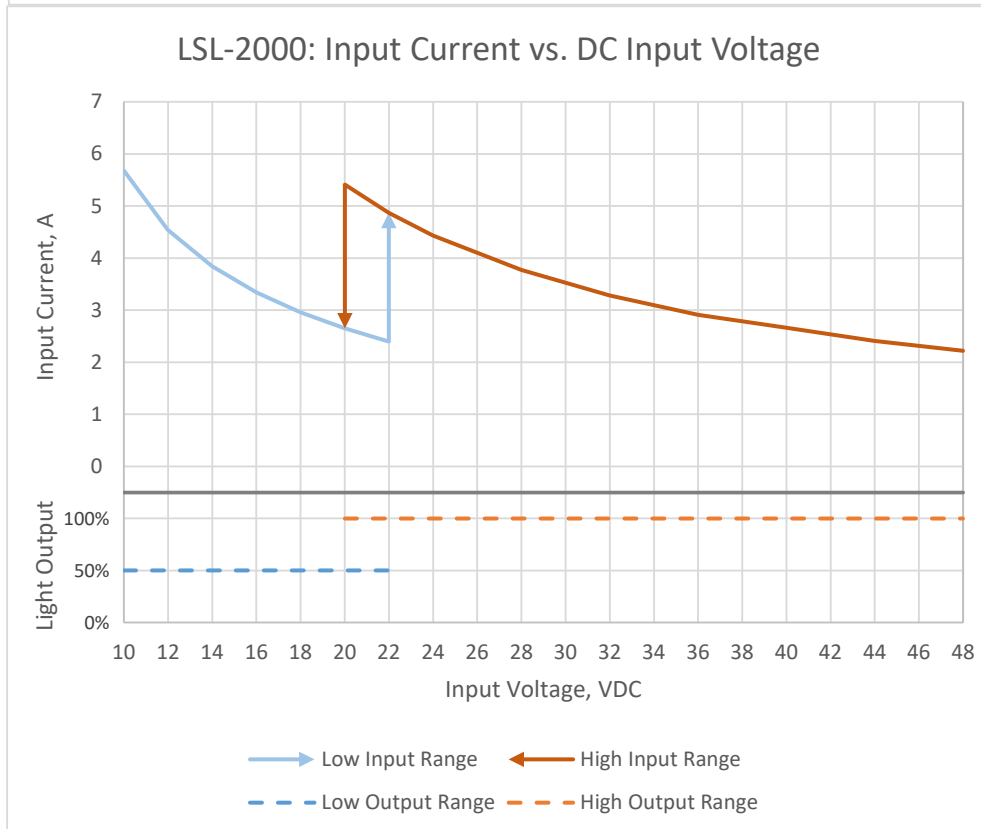
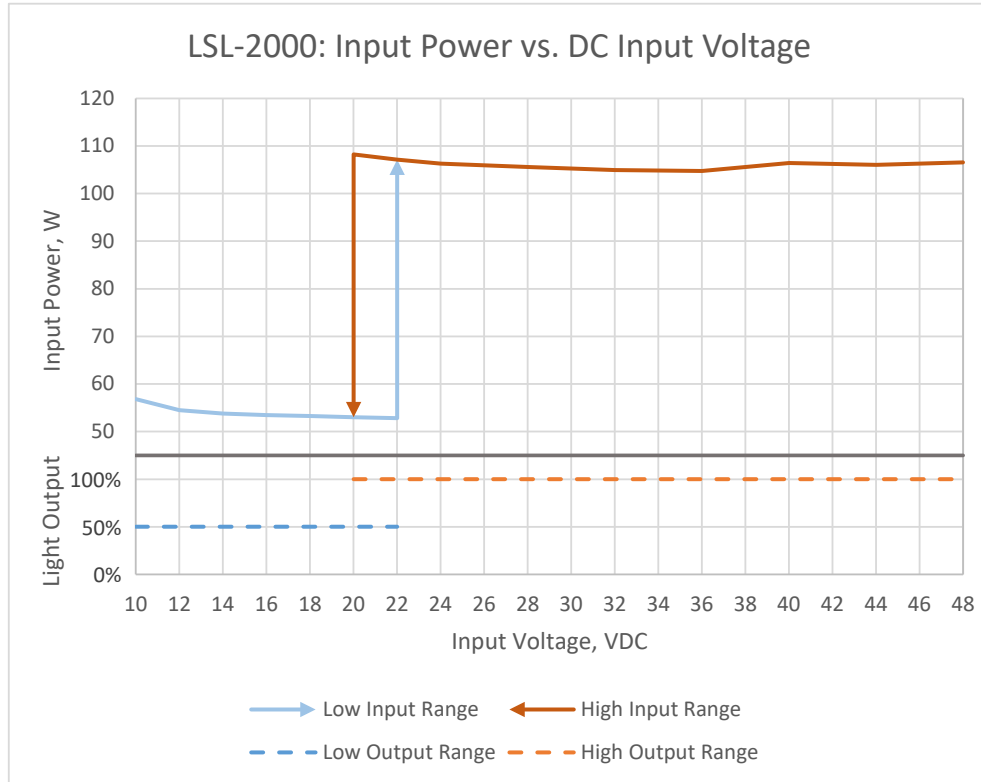

Appendix C

Dimming Curve

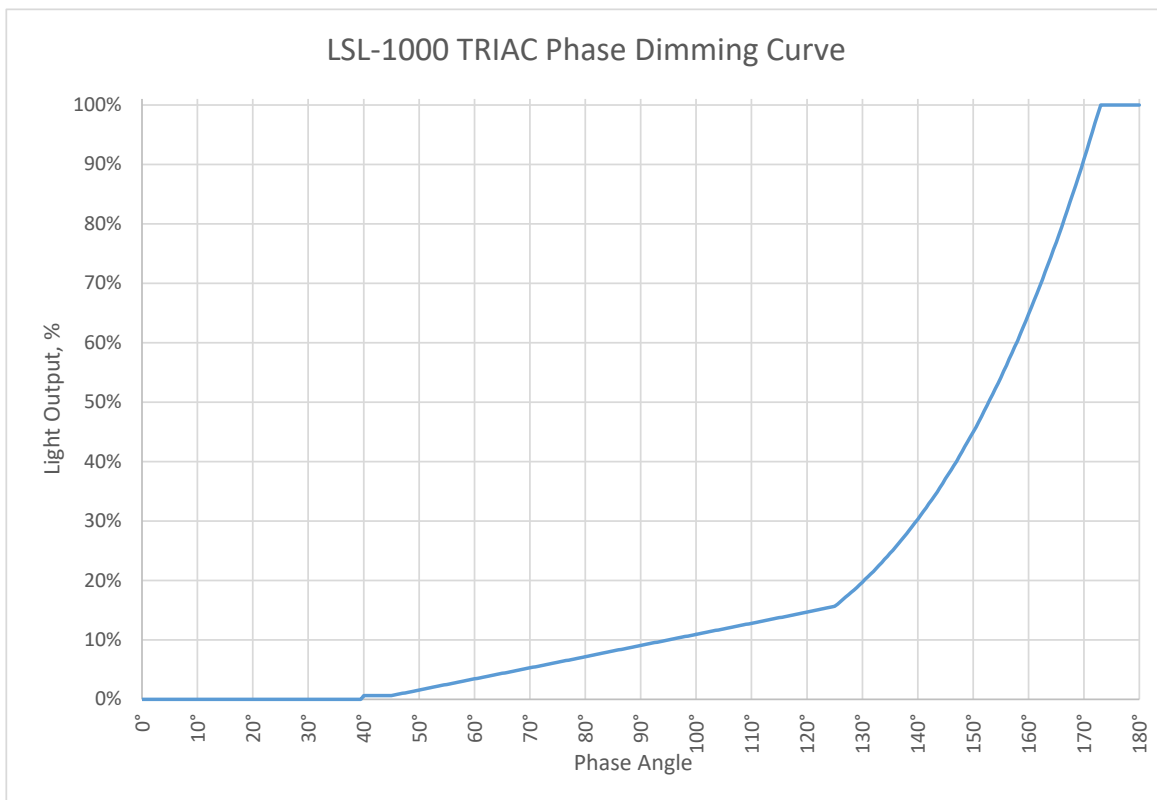
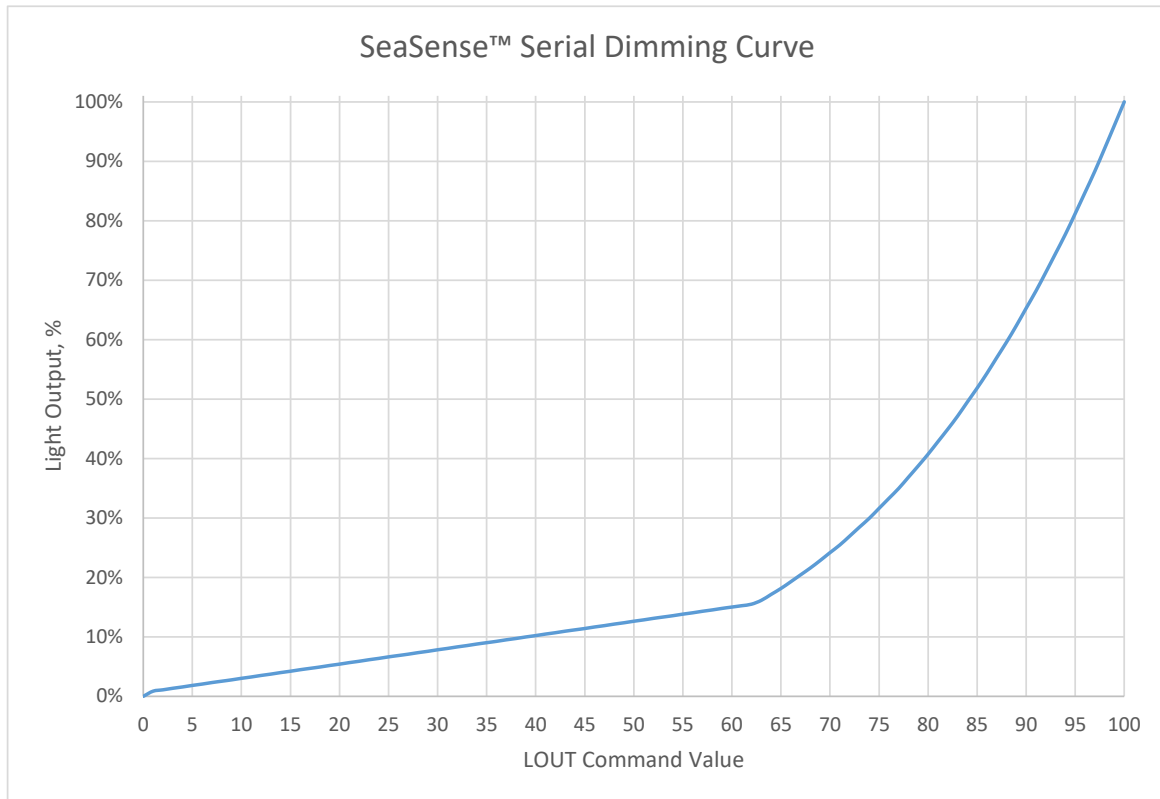

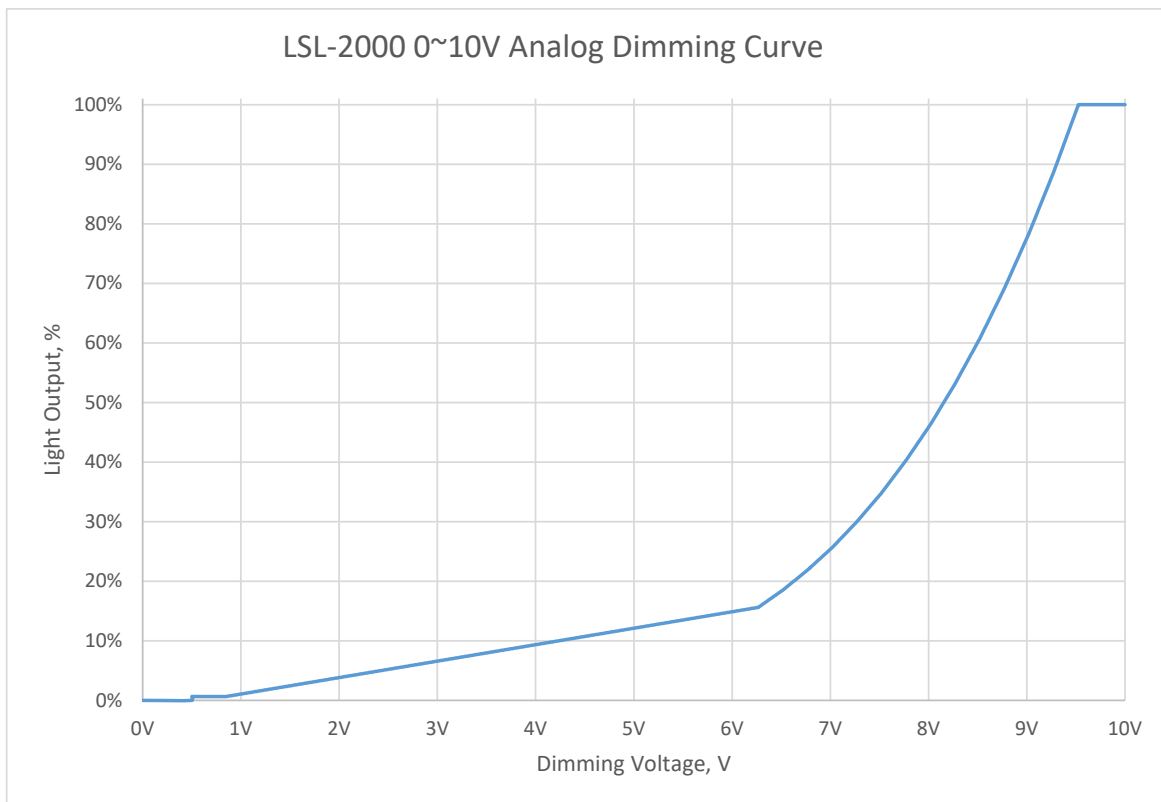
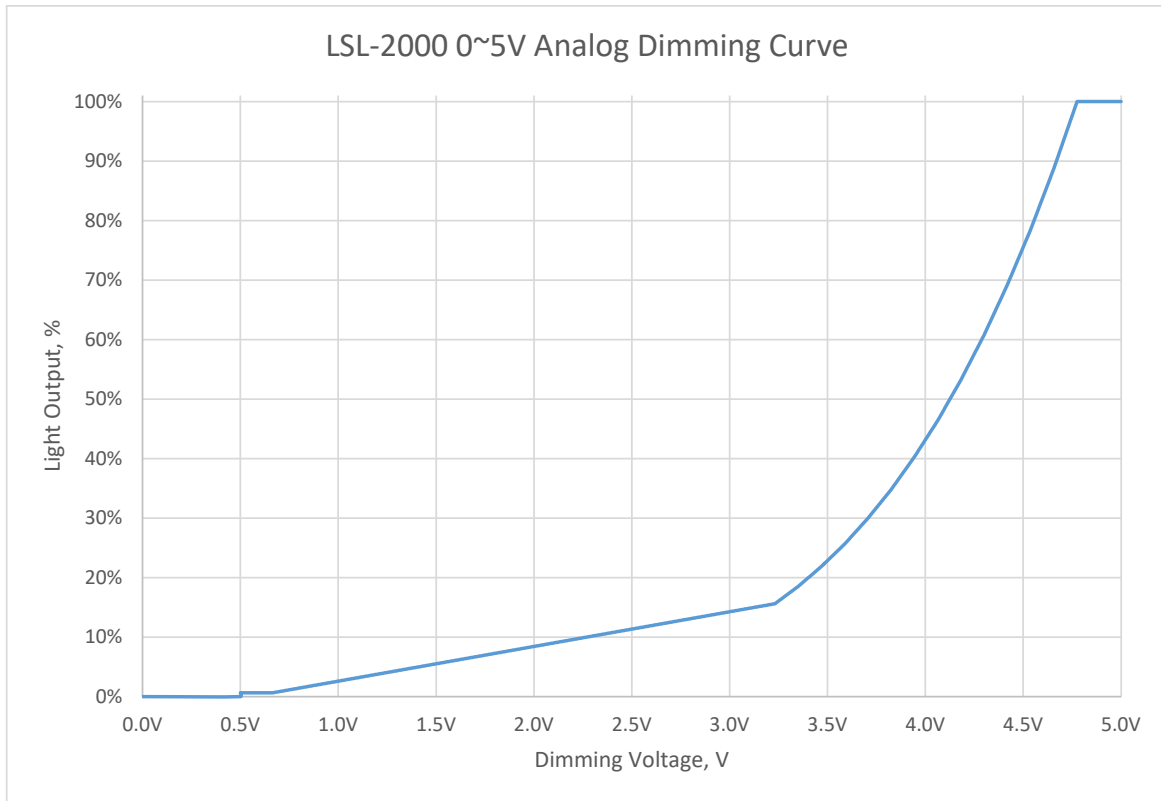

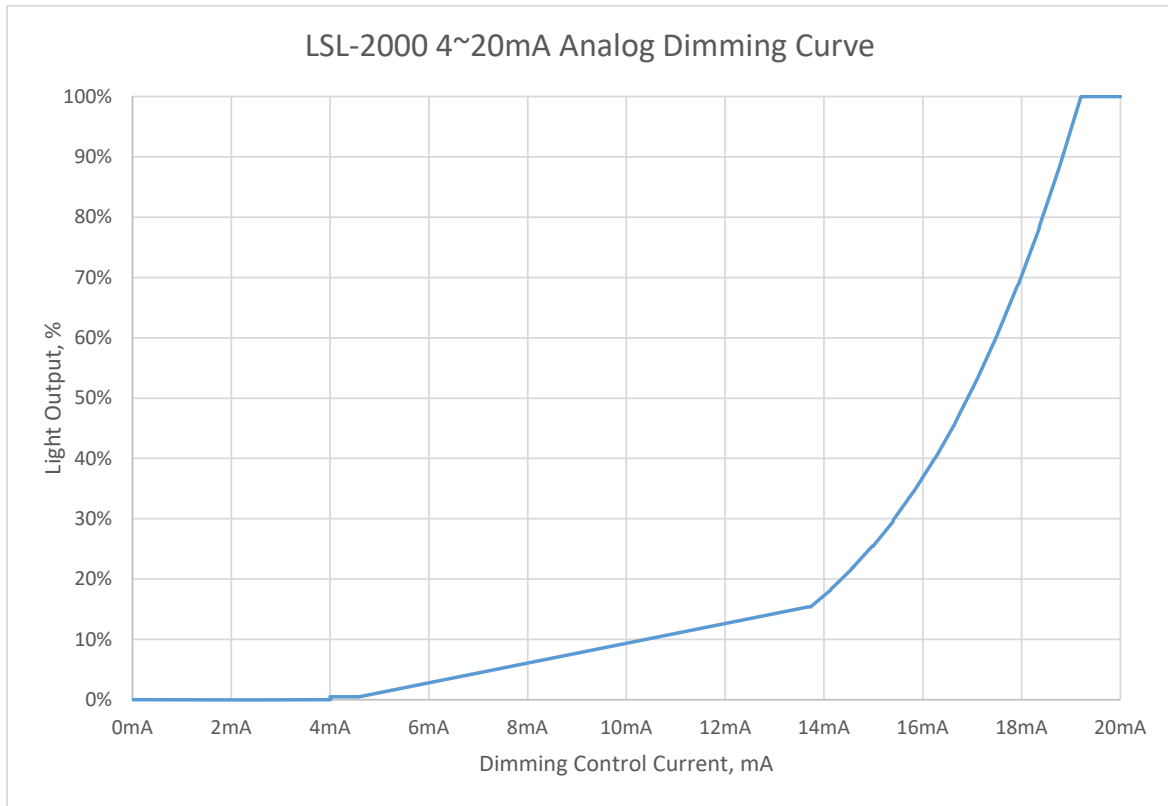

Appendix D

Beam Patterns



Radial Lux Distribution Comparison

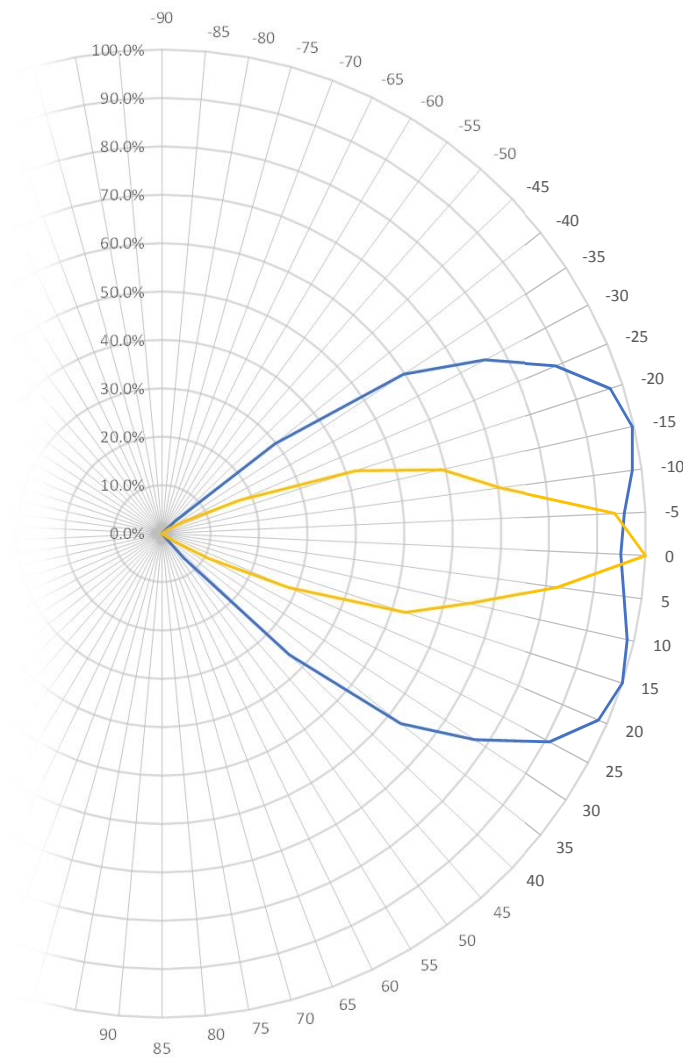

Angular Distribution

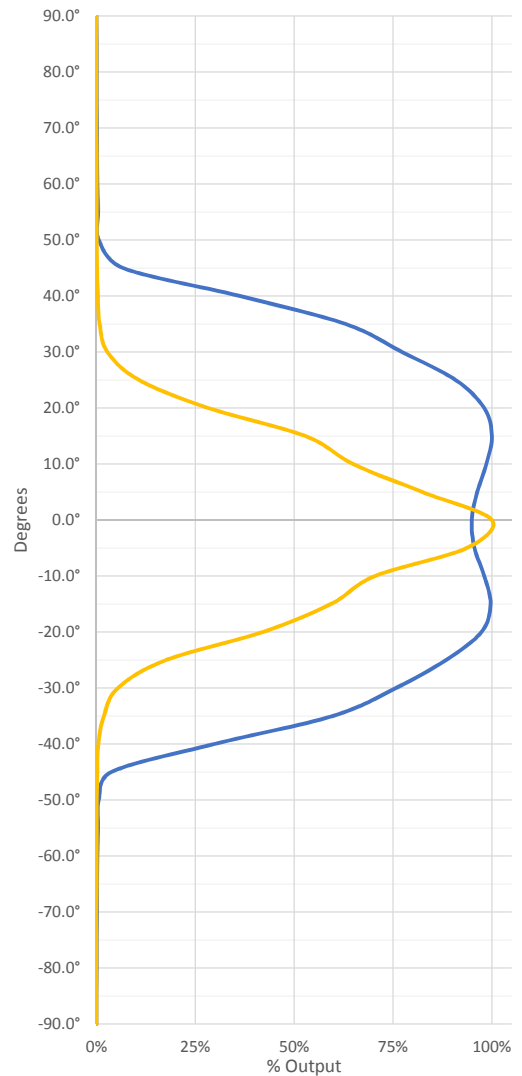

LED SeaLite Daylight White Flood LSL-1000-6KA-DW-075-PV-SUBMC3	
Peak Lux:	5680
FWHP Angle:	76

LED SeaLite Daylight White Spot LSL-1000-6KA-DW-035-PV-SUBMC3	
Peak Lux:	14400
FWHP Angle:	34

Appendix E

SeaSense™ Information

The DSPL SeaSense serial protocol is used to control enabled products in real-time over standard EIA-485 (RS-485) and EIA-232 (RS-232) industrial serial communications interfaces.

While the physical topology of these serial interfaces can differ significantly, this protocol is designed to operate equally well in each environment. The SeaSense protocol uses ASCII character commands, making them human readable. Strict command string formatting and an optional check-sum field offer robust, error-tolerant communications in harsh environments and mixed-protocol network installations. DeepSea strongly recommends host-side electrical isolation to the physical serial interfaces wherever serial interfaces are used in subsea environments to limit risks to the host platform as dangerous voltages may be present in the LED SeaLite.

The SeaSense protocol allows for an unparalleled flexibility in the use and operation of the LED SeaLite. Using the protocol, operators and system integrators can:

- Control the light output level and remap the dimming curve to fit application requirements.
- Monitor system parameters and diagnostic information such as total run time, internal temperature, and number of power cycles.
- Configure the serial interface by setting baud rates, device addresses, switching between EIA-232 or EIA-485 serial interfaces, and enabling a termination resistor for EIA-485 operation.
- Control power usage by putting the device into a low power standby mode or limiting the maximum light output level.
- Quickly switch between sixteen user preset states for light output and standby mode and configure the power-on state to one of these user presets.
- Operate multiple units over a single serial interface and use group addresses (up to 32 per device) or send global address to efficiently control more than one device with a single command.

The SeaSense Protocol Specification document is available at http://www.deepsea.com/wp-content/uploads/SeaSense_Protocol_Specification.pdf

Appendix F

USB Interface Driver Installation

1. Download the USB Interface Driver DSPL_virtualComPort under the Downloads tab at <http://www.deepsea.com/portfolio-items/led-sealite/>

Downloads

USB Interface Driver DSPL_virtualComPort.zip

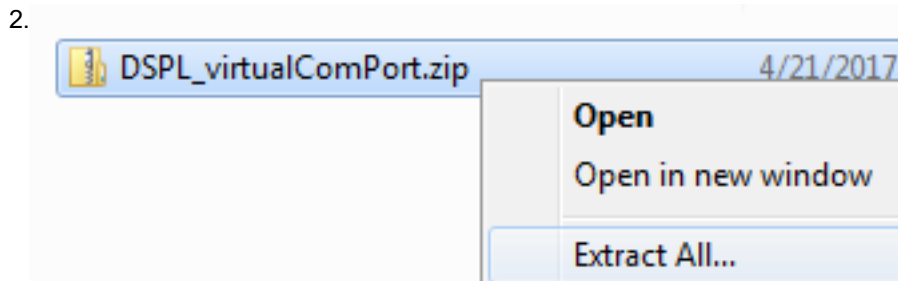

- b. Extract the contents of the zip file to a location you can find later (Ex: Downloads)
- c. Click **Extract**
3. Connect your LSL device USB to your computer, using a USB mini-B cable

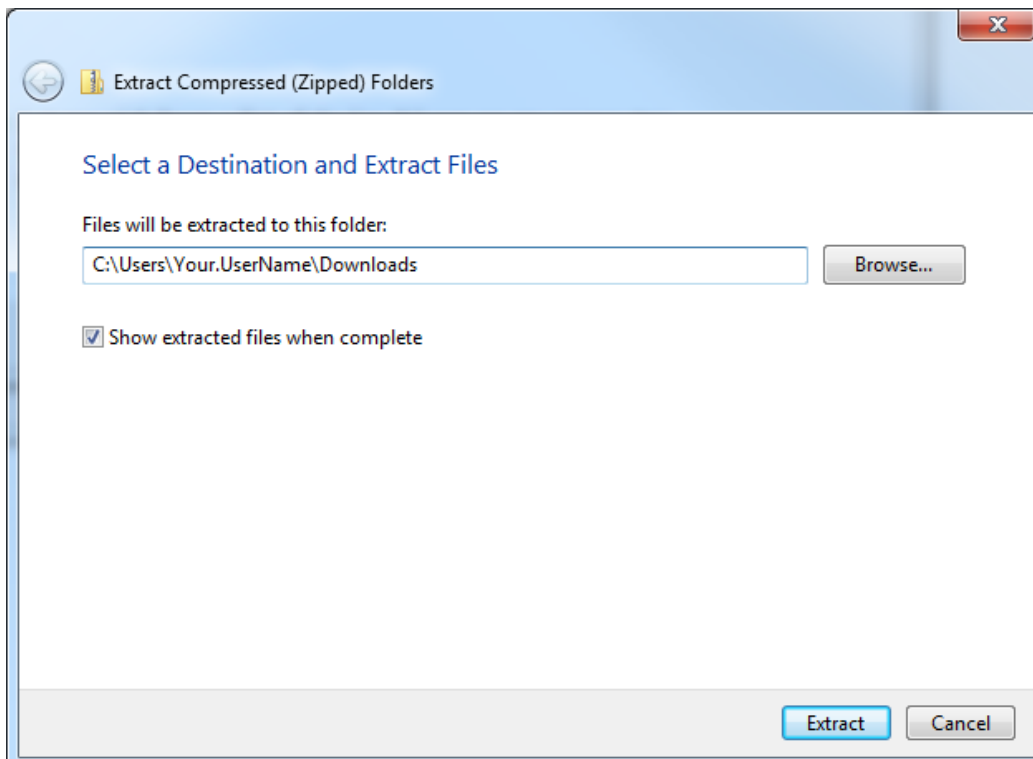

4. Open your **Start Menu** and search for "**Control Panel**"
5. From the **Control Panel**, open "**Device Manager**"

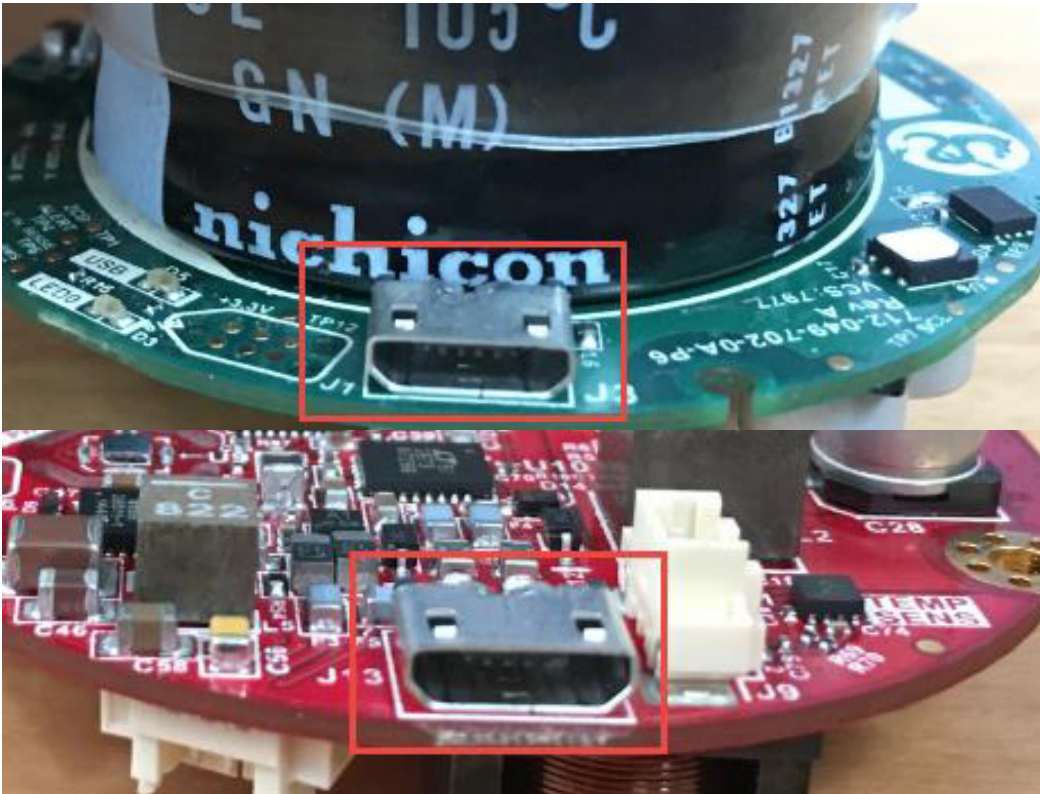

6. Inside the **Device Manager** window, locate **Other devices -> Unknown device**
7. Right click on **Unknown device** and click **Update Driver Software...**
8. Click on "**Browse my computer for driver software**"

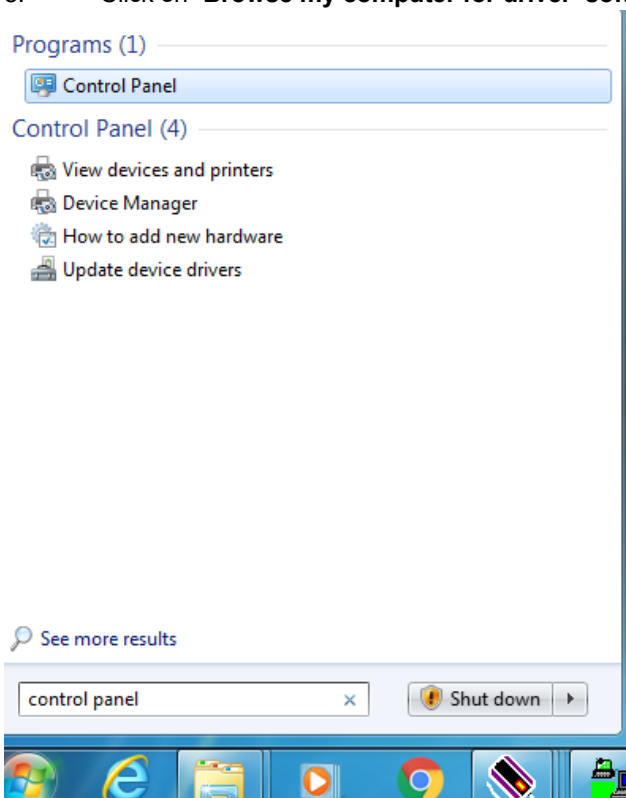

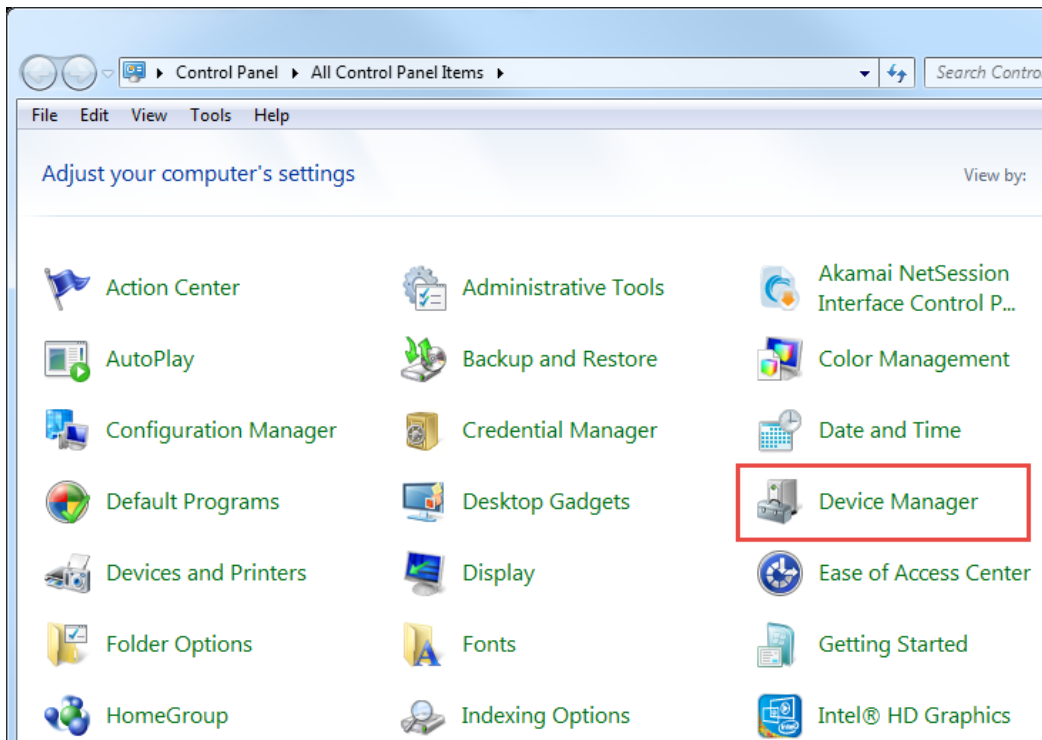

9. Click on **Browse...** and locate the folder you extracted from the first step
10. Click on **“Install this driver software anyway”**
11. You should have the following window:

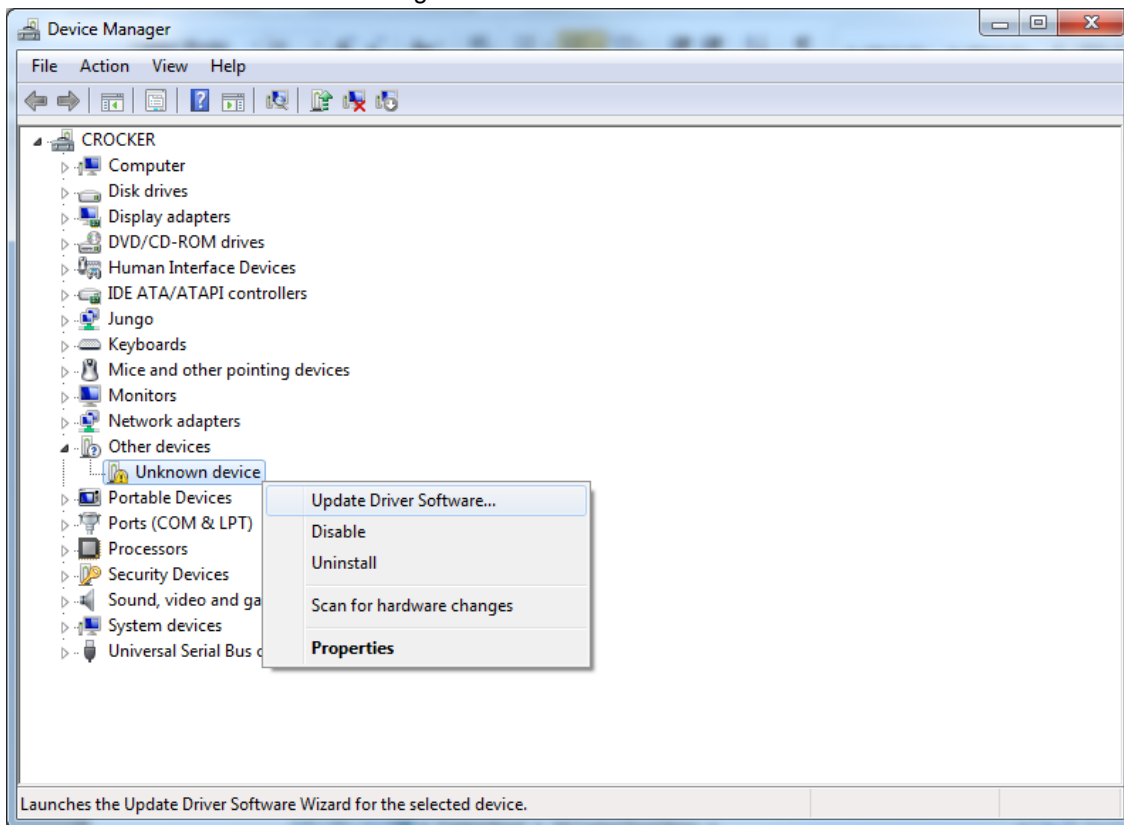

12. Go back to **Device Manager** and confirm that "**DSPL Com Port**" exists

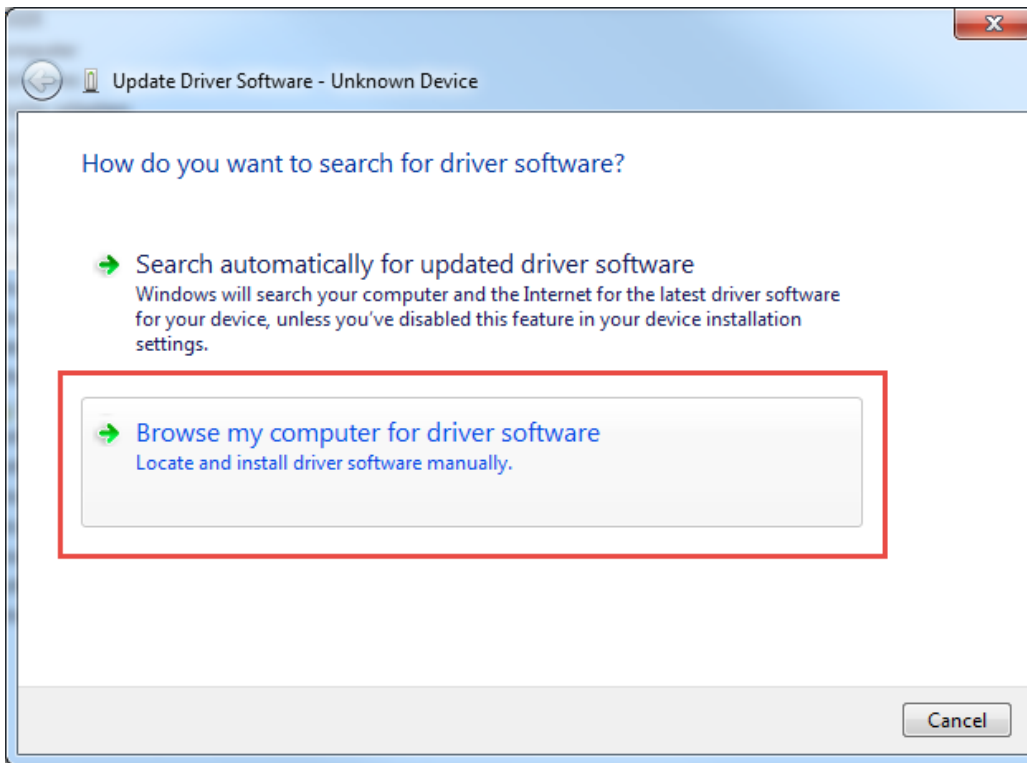

13. Use the COM port number to connect to your serial device.
a. If using firmware version **1.0.1.1684**, **RealTerm** is recommended

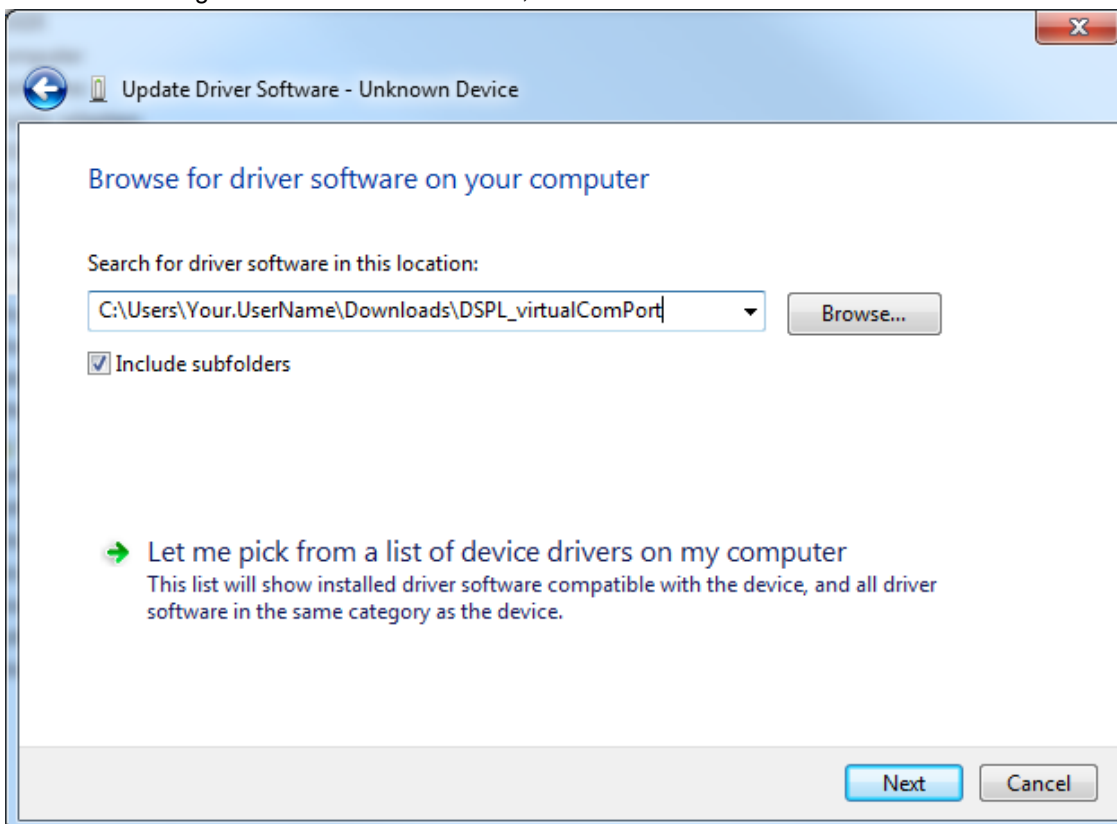

- b. If using firmware version **1.1.1685** or above, **TeraTerm** is recommended

14. Success! You may now communicate with your device over USB using the SeaSense protocol over any serial or

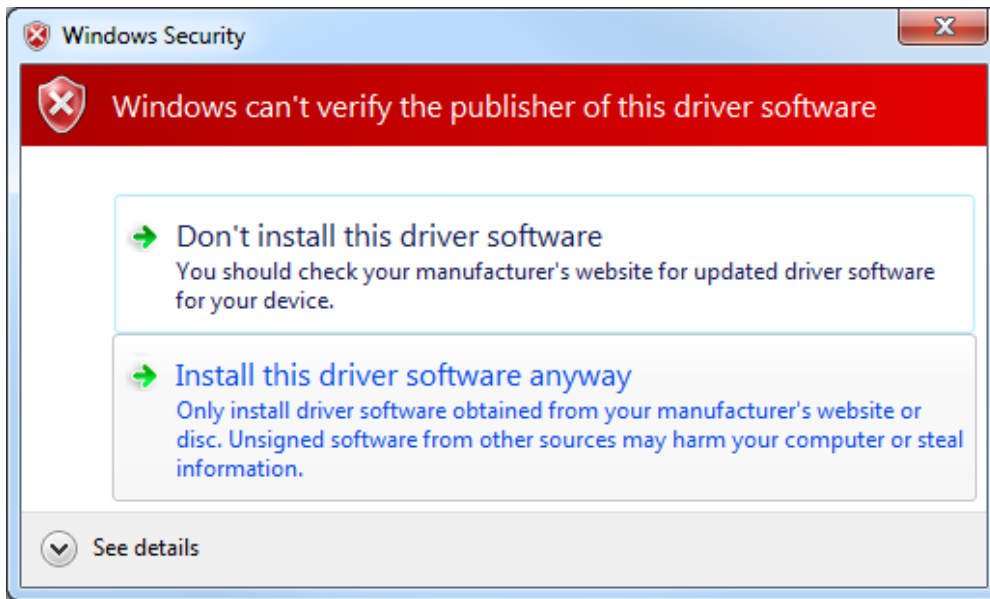

terminal program.

