

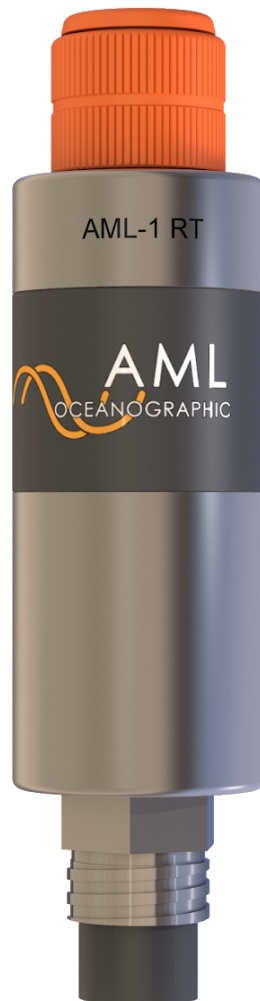

AML-1 RT: User Manual

Multiparameter Real Time Instrument





Revision History

Revision	Date	Description
1.1	29 Sept 2020	Document Created
1.2	27 April 2021	RS-485 Details Added

1 Introduction	4
1.1 Instrument Overview	4
1.2 Connectors and Cables	5
2 Getting Started	6
2.1 Interacting with the instrument	6
2.1.1 Typical Startup Sequence	6
2.1.2 Sensor Bootup	7
2.1.3 Streaming Data	7
2.1.4 Monitoring (Streaming) Data	8
2.1.5 Applications of Automonitor	8
2.1.6 Baud Rates	9
2.2 Common Settings and Configurations	9
2.2.1 Commands for Sound Velocity Sensors (SV and SVT•Xchange)	9
2.2.2 Commands for Pressure Sensors (P•Xchange)	11
3 Instrument Maintenance	12
4 Appendix A - Equipping an Instrument	13
4.1 Installing sensors	13
5 Appendix B - Contact AML	14
5.1 Service	14
5.2 Sales	14
6 Appendix C - Regulatory and Warranty Statements	15
AML Warranty Policy: New Product (Instrumentation)	15
7 Technical Overview	16

1 Introduction

The AML-1 RT is an ultra-compact externally powered single port instrument that provides real time (streaming) serial data from any AML X2change™ sensor. Compatible sensors are identified by their distinct orange collars.

There are a number of common applications for these devices, including:

- Pairing an AML-1 RT instrument with a Sound Velocity sensor to provide real time sound speed measurements for MBES applications
- Mounting a pressure sensor-equipped AML-1 RT on an underwater vehicle to stream depth information
- Installing an AML-1 with a combined conductivity and temperature sensor to calculate salinity data on a moored platform in real time.

The instrument relies on external power for operation and comes equipped with a single wet-mateable connector to facilitate power and data transmission.

The instrument itself has no configuration, but instead provides access to the command prompt of the installed sensor. **Configured behaviour such as baud rate, measurement frequency, formatting, etc, is programmed and persistent within the installed sensor, not the AML1-RT instrument.** For this reason, behaviour of the instrument may change with the installation of a new sensor, even if the parameter is identical to one previously installed.

1.1 Instrument Overview

Specifications

The following table describes specifications of the instrument only, unless noted otherwise.

Table 1: AML-1 RT specifications

Depth rating	6000 meters / 19,685 feet
Material	Titanium
Communication (RS-232)	Wet-Mate MCBH-6 Female, RS-232 Serial Communication (Bi-Directional Communication)
Communication (RS-485)	Wet-Mate MCBH-6 Female, RS-485 Half Duplex Serial Communication (One-way communication from instrument to host)
Power	Input voltage of 8-30V

	70mA at 8V, 20mA at 30V ¹
Temperature Operation Storage	-20 to +45°C -20 to +60°C
Dimensions Diameter Length Weight Weight in water	3.3 cm / 1.3 in 10.74 cm / 4.23 in (no sensor installed), 20.01cm / 7.88 in (SV•X2change™ sensor installed) 0.2 kg / 0.4 lb (no sensor installed) 0.11 kg / 0.25 lb (no sensor installed)

1 - Typical power draw when an SV sensor is installed. Other sensors may draw a different power.

1.2 Connectors and Cables

The AML-1 RT has only one connector, a 6-pin female (MCBH6F), located on the face opposite the sensor port. This connector is used to provide external power and serial communication during deployment. The instrument is factory set to either RS-232 or RS-485. The pin diagram for the connector is shown in Figure 1 below. Accompanying cables of various lengths are available with the AML-1 RT. Contact AML for details.

Pin	RS-232	RS-485
1	Rx - Signal	Tx - Signal B
2	Ground	Ground
3	Power (8-30 V)	Power (8-30 V)
4	Tx - Signal	Tx - Signal A
5	N/C	N/C
6	N/C	N/C

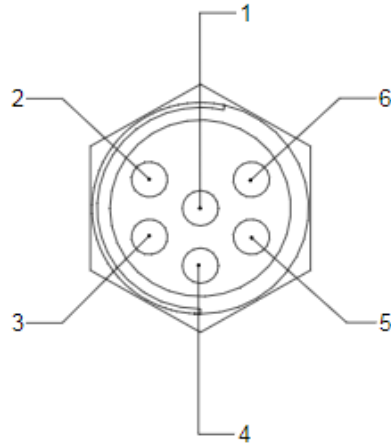

Figure 1: Left: Table of pin numbers and purposes. Right: Drawing of 6-pin female connector

2 Getting Started

This section provides an overview of basic instrument operation and functionality under a factory-default setup for most sensors. Specifically, this section describes how to connect to the instrument, change settings via terminal emulator, and stream sensor measurements.

Note that configuration is controlled within an installed sensor (not the AML-1 RT instrument), so some commands, features, and settings are sensor-specific.

Details describing how to change configuration and behaviour are described in Section 2.2.

2.1 Interacting with the instrument

Interaction with the AML-1 RT is facilitated by means of a terminal emulation program such as HyperTerminal, RealTerm, or Tera Term. Communication with the instrument must be established using the correct communications port and settings, described below:

- 8 bits
- 1 stop bit
- No parity
- No hardware handshaking
- Baud rate of 600, 1200, 2400, 4800, **9600**, 19,200 or 38,400 baud
 - 9600 is the default baud rate.

The default baud rate for most installed sensors is 9600. Note that this is not guaranteed however, as some sensors may be factory-configured to an alternative baud rate depending on application or request.

2.1.1 Typical Startup Sequence

To get an AML-1 RT device up and running, follow the procedure described below:

1. Ensure a sensor is fully installed on the port of the AML-1 RT instrument. The orange sensor collar should be hand-tight. **Do not use tools to tighten the collar.** Refer to *Appendix A - Equipping an instrument* for further details on installing a sensor.
2. Connect the provided underwater cable to the wet-mate connector on the end of the instrument. The opposing end of the cable will likely have a DB9 serial connector and flying power leads. Connect the serial cable to the PC via a serial port or USB-serial adapter.
3. Using a terminal emulator, configure the serial port as described in the previous section (Section 1.2) and open the serial port.

4. Connect the flying leads to a power source (8-30V) and apply power. This will immediately cause the instrument and sensor to boot.

2.1.2 Sensor Bootup

The basic startup sequence for all X2change sensors is identical. Default operation is for output to commence with a continuously transmitted identifying header sentence. This sentence is repeated at a rate of 20 Hz for approximately 2 seconds, after which the device automatically switches to streaming measurement data at a rate of 25 Hz.

An example bootup sequence is shown to the right. Upon the application of power, the X2Change sensor streams an identification header for 2 seconds, then switches to monitor mode where it will continuously stream data at a rate of 25 Hz.

In this example, the Sound Velocity sensor is in air so it is measuring 0000.000 m/s.

It is possible to interrupt the identifying header by sending a carriage return. The device will then switch to streaming measurements.

```
@S 209922 01/01/2000 0.021 SV.X 2d
@S 209922 01/01/2000 0.021 SV.X 2d
@S 209922 01/01/2000 0.021 SV.X 2d
@S 209922 01/01/2000 0.021 SV.X 2d
@S 209922 01/01/2000 0.021 SV.X 2d
@S 209922 01/01/2000 0.021 SV.X 2d
@S 209922 01/01/2000 0.021 SV.X 2d
@S 209922 01/01/2000 0.021 SV.X 2d
@S 209922 01/01/2000 0.021 SV.X 2d
@S 209922 01/01/2000 0.021 SV.X 2d
@S 209922 01/01/2000 0.021 SV.X 2d
@S 209922 01/01/2000 0.021 SV.X 2d
@S 209922 01/01/2000 0.021 SV.X 2d
@S 209922 01/01/2000 0.021 SV.X 2d
@S 209922 01/01/2000 0.021 SV.X 2d
@S 209922 01/01/2000 0.021 SV.X 2d
@S 209922 01/01/2000 0.021 SV.X 2d
@S 209922 01/01/2000 0.021 SV.X 2d
@S 209922 01/01/2000 0.021 SV.X 2d
0000.000
0000.000
0000.000
0000.000
...
```

2.1.3 Streaming Data

After bootup, data streaming will continue indefinitely until interrupted by a power cycle or by sending any ASCII character. When halted, the AML-1 RT will land at a command prompt, as shown below:

```
0000.000
0000.000
0000.000
0000.000
0000.000
0000.000
>
```

It is possible to configure the automatic behavior of a sensor after it's identification strain transmission. For example, a sensor may be configured to land at prompt and await further commands, or alternatively may be configured to immediately stream data (the default behavior described here). For sound velocity sensors (SV and SVT•Xchange), relevant commands are listed in *Section 2.2 - Common Settings and Configuration*.

2.1.4 Monitoring (Streaming) Data

To commence streaming data, send the *monitor* command:

```
>monitor  
0000.000  
0000.000  
0000.000  
0000.000  
0000.000  
0000.000  
0000.000  
0000.000  
0000.000  
...
```

The instrument will stream measurements indefinitely until halted.

2.1.5 Applications of Automonitor

In some applications it is undesirable to have streaming data interrupted by receipt of any ASCII character. For example, noise on a communication line may be inadvertently interpreted as a character, halting sensor operation. In these cases, best practice is to configure the sensor to automatically recommence data streaming after a period of inactivity when at prompt. This is achieved using the command *set automon x*, where 'x' is the elapsed time of inactivity in milliseconds. For example, to configure a sensor to re-commence data streaming after 2 seconds of inactivity (when at prompt), send the following command:

```
>set automon 2000  
>  
0000.000  
0000.000  
0000.000  
0000.000  
...
```

In this configuration, if the instrument's streaming data is halted (either deliberately or inadvertently) then it will land at prompt, wait two seconds, then re-commence streaming. It is recommended that this configuration be used for MBES applications.

Automonitor may be turned off by setting the period of inactivity to '0': *set automon 0*.

2.1.6 Baud Rates

It is possible to alter the baud rate of the device. This is achieved by using the command *set outbaud x*, where 'x' refers to the desired baud rate. For example, to switch to a baud rate of 19200, send the following:

```
>set outbaud 19200  
Switching to 19200 baud now. Please adjust terminal baud rate  
+
```

Note that the baud rate adjustment occurs immediately, without the requirement for a power cycle.

This command is persistent. Output data will be transmitted at this baud rate until it is changed again via command.

Baud rate adjustment applies to all instrument interaction after the startup identifying header is complete, but it does not adjust the baud rate at which the identification head string is communicated. The startup header will always remain at 9600 baud unless adjusted by the factory. For example, if the device is configured to use 19200 baud using *set outbound 19200*, then after a power cycle the device will transmit its header information at 9600 baud for 2 seconds, then immediately switch to 19200 baud for the remainder of its operation.

Baud rate settings (like all settings) are sensor-specific, so if a non-default baud rate is used in an application, sensors substituted in will require similar setup.

2.2 Common Settings and Configurations

It is common for an AML-1 RT to be paired with either an AML SV•X2change™ (sound velocity sensor) or SVT•X2change™ (combined temperature and sound velocity sensor). Most commands are common to both sensors, with the exception of some commands that adjust temperature measurement functionality particular to the SVT sensor.

Most MBES stipulate a particular data format for compatibility and users should check with the manufacturer for detailed requirements. It is possible to configure an SV or SVT-equipped AML-1 RT to be compatible with the majority of MBES systems.

2.2.1 Commands for Sound Velocity Sensors (SV and SVT•Xchange)

When paired with an SV or SVT sensor, the device will stream sound velocity measurements in units of m/s, and temperature measurements (in the case of SVT) in units of °C.

The table below provides a summary of typical commands which are common to both SV and SVT•Xchange sensors.

Table 2: Common Settings for both SV and SVT•X2change™ sensors

Setting	Applicable Command	Description	Default	Alternate Options
Identify firmware version	DISPLAY VERSION	Will provide sensor name and installed firmware version	-	-
Monitor on Startup	SET STARTUPMONITOR YES/NO	If YES, the instrument will start streaming data when power is applied. If NO, device will await a command after header information.	Yes	No
Output Rate	SET OUTPUTRATE xxx	Time between provided measurements in ms (1/output frequency)	40ms (25 Hz)	40ms-1000ms
Automonitor	SET AUTOMONITOR xxx	Instrument will start to stream data after user interrupt, time specified in milliseconds of inactivity	0s, will not start streaming	User configurable up to 100s
Leadingspace	SET LEADINGSPACE YES/NO	Adds a leading space to the output stream. Used to emulate output from legacy Micro•X instruments.	no	yes
Format of SV output	SET SVFORMAT XY	X is number of digits before decimal. Y is number of digits after decimal.	43 (xxxx.yyy)	User configurable
Baud rate	SET BAUD x	X is desired baud rate. Effective immediately (without power cycle). Does not alter ident. header baud rate.	9600	9600, 19200, 38400, 57600, 115200
SV sample averaging	SET SVAVG x	Rolling 'boxcar' average. Continuously averages last 'x' samples. Note: increasing averages will smooth output data but reduce response time.	8	1-100

SVT•Xchange sensors have some additional functionality pertaining to temperature measurements. These commands are summarized below.

Table 3: Common Settings for SVT•X2change™ sensors

Setting	Applicable Command	Description	Default	Alternate Options
Temperature format	SET TEMPFORMAT xy	X is number of digits before decimal. Y is number of digits after decimal.	'23' ('XY' = xx.yyy)	User configurable
Temperature output on/off	SEC 652 TEMPDISPLAY YES/NO	Controls whether or not a second column is streamed displaying	yes	no

		temperature. This is a secure command, and must be preceded with 'SEC 652'.		
Temperature averaging	SET TEMPAVG x	Rolling 'boxcar' average. Continuously averages last 'x' samples. Note: increasing averages will smooth output data but reduce response time.	4	1-100

2.2.2 Commands for Pressure Sensors (P•Xchange)

When paired with a pressure sensor, the device will stream measurements in units of dBar.

The table below summarizes typically used commands for P•X2change sensors.

Table 3: Common Settings for P•X2change™ sensors

Setting	Applicable Command	Description	Default	Alternate Options
Identify firmware version	DISPLAY VERSION	Will provide sensor name and installed firmware version	-	-
Baud rate	SEC 652 SET BAUD x	X is desired baud rate. Effective immediately (without power cycle). Does not alter ident. header baud rate.	9600	9600, 19200, 38400, 57600, 115200
Automonitor	SET AUTOMONITOR xxx	Instrument will start to stream data after user interrupt, time specified in milliseconds of inactivity	0s, will not start streaming	User configurable up to 100s
Taring the sensor	ZERO	Will automatically tare the sensor by applying current readings as an offset. This command should be applied while the sensor is in air.	-	-
Data format	SET DATAFORMAT xy	X is number of digits before decimal. Y is number of digits after decimal.	2	4
Pressure averaging	SET SAMPLESTO AVERAGE x	Rolling 'boxcar' average. Continuously averages last 'x' samples. Note: increasing averages will smooth output data but reduce response time.	1	1-4096

3 Instrument Maintenance

Periodic preventative maintenance will prolong the life of the instrument. The following steps are recommended:

- If the instrument is dirty or oily, allow it to soak in warm, soapy water before cleaning with a rag or soft brush. When finished, rinse with fresh water to remove any residual soap or dirt.
- Before each use:
 - Check for proper installation of the X2change™ sensor (Appendix B)
 - Check for nicks and cuts on the cable.
- After each use:
 - Clean and rinse the instrument using fresh water.
 - Dry the instrument completely, and store it in a cool, dry place.
- Monthly:
 - Apply a layer of Molykote 44 medium silicone grease to the female half of the connection as shown and fully insert the plug. Wipe away any excess that squeezes out. This will lubricate both male and female connectors.

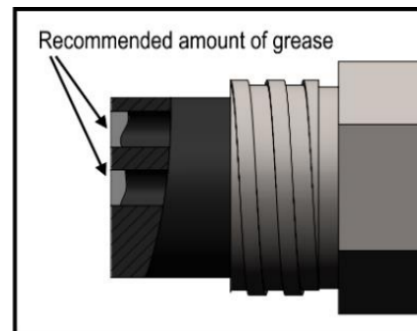

- Yearly:
 - Send the instrument or X2change™ sensors to a service centre for diagnostics and re-calibration

4 Appendix A - Equipping an Instrument

AML-1 RT is part of AML's X2change instrumentation ecosystem. Any sensor within this ecosystem is compatible with any instrument. Sensors are identified by orange collars, and instruments are identified by black decals on the instrument body and orange colouring within the sensor ports. Only 'orange' sensors may be installed on 'orange' instruments. The previous generation of blue-collar Xchange sensors are not compatible.

The process below describes the typical method for installing and removing sensors from an instrument.

4.1 Installing sensors

1. Before installing X2Change™ sensors, ensure that the sensor port is clean and dry. Also confirm that the port is 'orange' compatible by visually confirming the precedence of orange coloring at the bottom of the port.
2. Check the X2Change™ sensor's o-rings for cleanliness and replace if damaged. Apply o-ring grease to the new o-ring before replacing it.
3. Align the sensor with the sensor port so that the key of the mating connector pins are aligned. Key alignment is important - it can be difficult to insert a sensor if the clocking is not correct.
4. Place the sensor into the port and press the sensor in to compress the o-rings. Confirm correct alignment of the key by pressing the sensor body into the port and twisting the sensor. It will be possible to feel the key engage.
5. Push the sensor until it drops down into the port enough to allow the orange locking sleeve threads to engage the port threads.
6. Hand-tighten the orange locking sleeve until it stops. The bottom of the sleeve should be within 1 mm of the instrument end cap. Note: the collar is NOT intended to sit flush on the instrument endcap. **Never use tools to tighten the locking collar.**



5 Appendix B - Contact AML

5.1 Service

To request an RMA or technical support

Email: service@AMLoceanographic.com

Phone: 1-250-656-0771

Phone: 1-800-663-8721 (NA)

<http://www.AMLoceanographic.com>

5.2 Sales

For all general sales inquiries

Email: sales@AMLoceanographic.com

Phone: 1-250-656-0771

Phone : 1-800-663-8721 (NA)

<http://www.AMLoceanographic.com>

6 Appendix C - Regulatory and Warranty Statements

This product is compliant within the requirements of CE standards.



AML Warranty Policy: New Product (Instrumentation)

AML warrants the instrument and sensor for a period of TWO YEARS (24 months) from the date of delivery. AML will repair or replace, at its option and at no charge, components which prove to be defective. The warranty applies only to the original purchaser of the instruments and only to instruments and sensors manufactured by AML Oceanographic. The warranty of third party sensors will apply as per the specific vendor's warranty policy. The warranty does not apply if the instrument has been damaged, by accident or misuse, and is void if repairs or modifications are made by other than authorized personnel.

This warranty is the only warranty for new products given by AML. No warranties implied by law, including but not limited to the implied warranties of merchantability and fitness for a particular purpose shall apply. In no event will AML be liable for any direct, indirect, consequential or incidental damages resulting from any defects or failure of performance of any instrument supplied by AML.

7 Technical Overview



AML-1 RT, With CT.X2 Installed
 - 6000m Rated

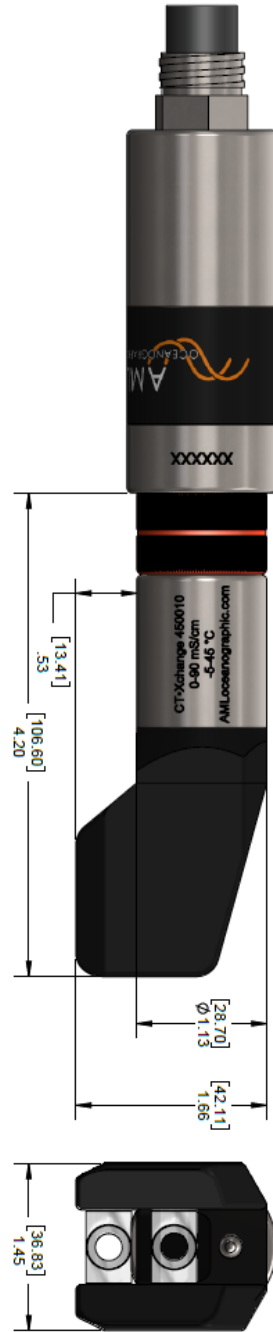

AML-1 RT, With P.X2 Installed
 - Pressure limited by sensor rating



Notes:
 All Dimensions in [mm] and Inches

		AML-1 RT SYSTEM	
AML-1 Dimensional Overview			
DRAWING NUMBER ONE-GA-04668		DATE 28 Sep 2020	
A300-2281 Keating Cross Road Victoria, BC, Canada, V8M 2A5 Tel: +1 250-456-0771 Fax: +1 250-456-3656 www.AMLoceanographic.com		THE INFORMATION CONTAINED IN THIS DRAWING IS THE SOLE PROPERTY OF AML OCEANOGRAPHIC. ANY REPRODUCTION IN PART OR WHOLE WITHOUT THE WRITTEN PERMISSION OF AML OCEANOGRAPHIC IS PROHIBITED.	
Sheet 2 of 3			

RS-232 / RS-485 Communications

MCBH-6-FS
Bulkhead Face View

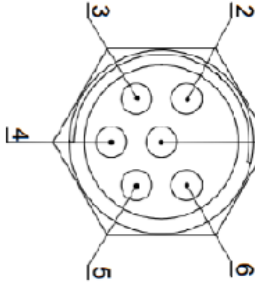

RS-232 COMMUNICATIONS (default)

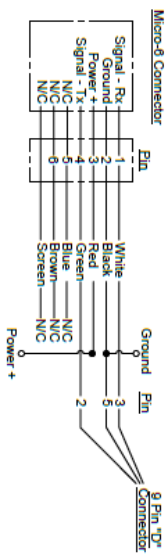

RS-485 COMMUNICATIONS

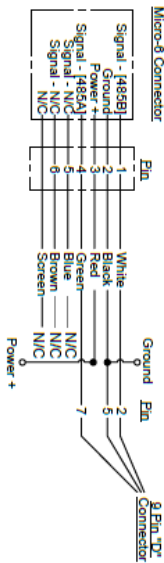

Note:
AML-1 RT Instruments are configured at the factory for either RS-232 or RS-485 serial communication. Contact AML Oceanographic for details.

		AML-1 Dimensional Overview <small>TITLE</small>	
A300-2261 Keating Cross Road Victoria, BC, Canada, V8M 2A5 Tel: +1 250-466-0771 Fax: +1 250-465-3656 www.AMLoceanographic.com		<small>DRAWING NUMBER</small> ONE-GA-04668	<small>SIZE</small> AML-1 RT
<small>DATE</small> 28 Sep 2020		<small>THE INFORMATION CONTAINED IN THIS DRAWING IS THE SOLE PROPERTY OF AML OCEANOGRAPHIC. ANY REPRODUCTION IN PART OR WHOLE WITHOUT THE WRITTEN PERMISSION OF AML OCEANOGRAPHIC IS PROHIBITED.</small>	
<small>Sheet 3 of 3</small>		<small>Sheet 3 of 3</small>	