

ALGIZ 10X

MANUAL





handheld

INDEX

What's in the Box	4
1. IDENTIFYING ALGIZ 10X	5
Specification	5
System.....	5
Display Specification	5
I/O Connectors	5
Buttons and Indicators	5
COM Port Assignment.....	6
Boot Options.....	6
Factory Reset.....	6
Front Side	7
Left and Right Side	8
Rear Side	9
Function Keys	10
LED Indicators	10
LED Term.....	10
2. USING ALGIZ 10X	11
AC Power	12
Battery Power	12
Insertion of the Battery Pack	13
Removal of the Battery Pack	13
Charging the Battery.....	14
Power Supply.....	14
Starting ALGIZ 10X	15
Installing SIM Card, SD Card.....	15
3. SOFTWARE	16
Hot-Tab.....	17
Adjusting the LCD Brightness	17
Adjusting the Speaker Volume	18
Battery Status	18
WLAN (1).....	19
Bluetooth (2).....	19
WWAN (LTE) - Optional	20
GPS.....	21
Camera	23
External GPS Antenna	26

External WWAN Antenna	27
System Information.....	28
4. REGULATORY INFORMATION	29
FCC Compliance Statement.....	30
FCC Warning	30
FCC RF Radiation Exposure	30
Copyright Notice	31
Trademark Acknowledgement	31
Disclaimer	31
Customer Service.....	31

What's in the Box

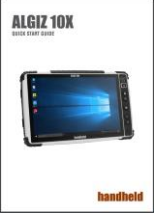
Item	Description
	One 2 Cell Li-Ion Battery Pack
	19V Adapter w/ standard power cord. Standard type, 1.8M
	Handstrap
	ALGIZ 10X Quick start guide

PART 1:

IDENTIFYING ALGIZ 10X

Specification

ALGIZ 10X is a rugged tablet PC designed for use in various challenging environments, e.g. field work, outdoor activities and construction sites. With its rugged design, ALGIZ 10X is able to withstand shocks, vibrations, high humidity as well as high/ low temperatures.

System	
Processor	Intel® Celeron® N2930 Quad Core 1.83 GHz Processor
BIOS	AMI System BIOS
Chipset	Intel ATOM Soc Integrated
Memory	SODIMM, DDR3L 1600 4GB
LAN Controller	Intel® Ethernet Controller I211-AT
Storage	SATA interface support Mini-PCIe interface SSD 128GB
Audio	Audio-out / Audio-in / Microphone-in. Internal Speaker

Display Specification	
Size	10.1" (16:10)
Resolution	1920 x 1200
Brightness	600 cd/m2 (typ.)
Touch	10 points projective capacitive touch

I/O Connectors	
Left Side	1xDC Power Jack, 1xVGA, 1xUsb 2.0,1xRS232
Right Side	1xLAN, 1xUSB 3.0, 1xMic/Audio Jack, 1xSIM Card Slot, 1xMicro SD Card Slot
Bottom Side	Pogo-pin for docking
Rear Side	Service Window

Buttons and Indicators	
Control Button	Power On/Off, Menu, windows key, two programmable hotkeys
LED Indicators	Power Status, SSD Status, RF Device Status, Battery Status, GPS Status

COM Port Assignment

COM1	RS232
COM2	B+ Power & UART Wafer
COM3	GPS
COM6	WWAN virtual COM
COM7	WWAN virtual COM
COM8	WWAN virtual COM
COM11	Docking Station
COM12	Docking Station

Boot Options

F1	Initiate factory reset
F2	Enter BIOS

Factory Reset

The ALGIZ 10X has a built-in **recovery utility** that can be used to reset your computer's SSD disk to its factory state. Press F1 during booting when the Handheld logo screen appears. Follow the instructions on the screen to continue with the factory reset.



CAUTION: This procedure will erase all data on your disk.



Front Side

Ref.	Item	Description
1	Front Microphone	Receives sound to make voice recordings.
2	Light Sensor	Senses the ambient light for automatic adjustment of the display backlight. The features can be enabled through the OSD Control Keypad.
3	Keypad	The Keypad provides hotkeys with all functions including Power On/Off, Menu, programmable hotkeys and a Windows Home key
4	Speaker	Front Speaker

Left and Right Side

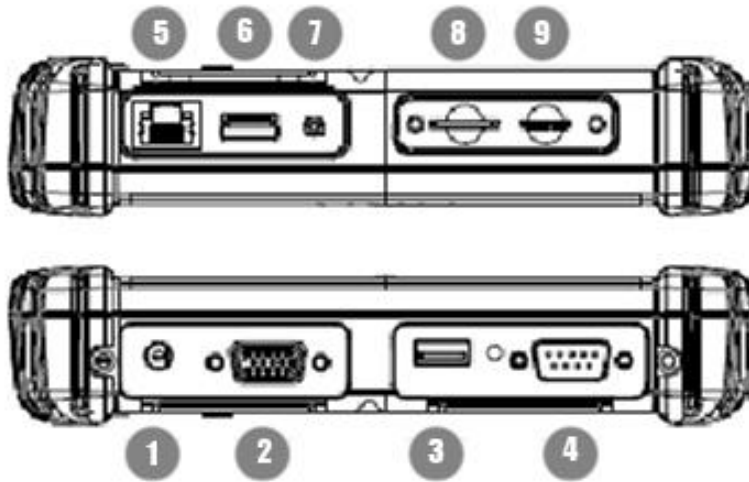

Ref.	Item	Description
1	DC Power Jack	DC plug for supplying power to the device
2	VGA	For connection to external display devices such as monitors and projectors
3	USB 2.0 Port	Can be connected to USB-interface peripherals
4	RS232	Accepts external connections using the interface of RS232 (D-sub 9 pins)
5	Ethernet(RJ45) Port	For connection to an Ethernet 10/100/1000-based network
6	USB 3.0 Port	Can be connected to any USB-interface peripherals
7	Combo Audio Jack	For connection to a set of headphones or external speakers.
8	SIM Card Slot	Accepts a SIM Card, use the WWAN feature to connect to the Internet.
9	Micro SD Card Slot	Accepts a Micro SD Card for additional features.

Rear Side

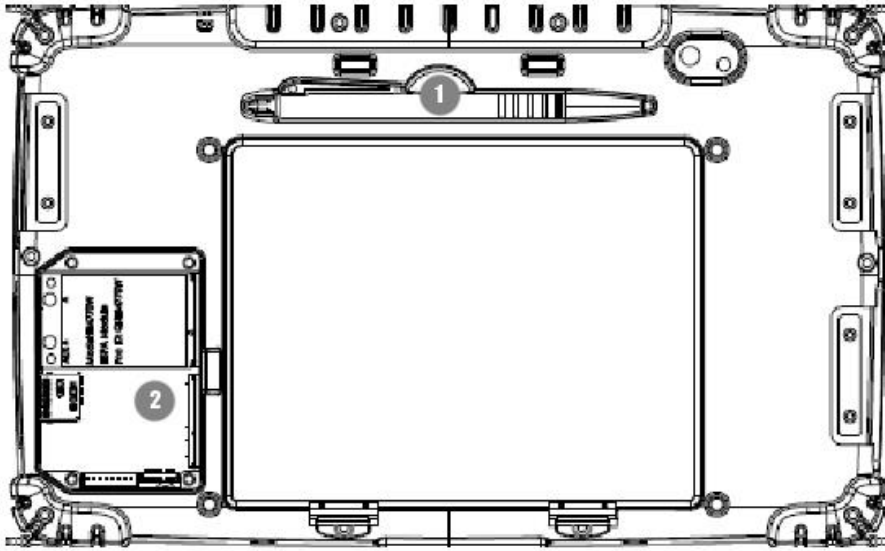

	Item	Description
1	Stylus Pen	
2	Service Window	User-accessible compartment.



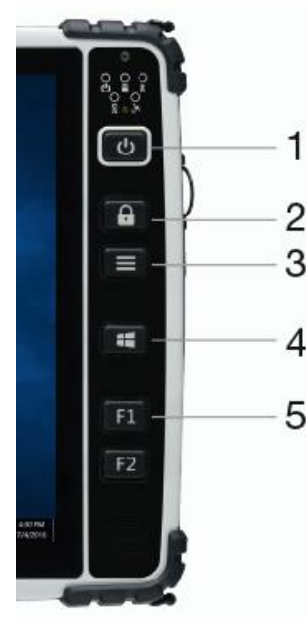

Function Keys

	Components	Description
1	Power Button*	Hold down for 4 seconds to turn the computer on.
2	Touch mode/lock	Touch mode selection. Lock screen.
3	Menu	Controls brightness, volume, battery, power to modules and system information.
4	Windows key	Open start menu
5	Function keys	Two programmable buttons. Press menu to configure.



* If computer does not respond you can power it off by holding down the Power Button until the LEDs are switched off. Hold down for about 10 seconds.

LED Indicators

LED Term	Symbol	Indicator Status Description
Power mode		Green: System is on No light: System is off or LED indicators are off in Hot-tab.
Storage Status		Flashing green light: SSD is reading/writing data
Radio Status		Green: Indicates that any transmitting radio is turned on. (WiFi, BT, WWAN)
Battery Status		Green: Full battery Red: Low battery Orange: Charging Flashing red: Running on Hot-swap battery
GPS Status		Green: Indicates GPS power on

PART 2:
USING ALGIZ 10X

Before turning the unit on, make sure that the tablet is either connected to AC power or the battery.

AC Power

The ALGIZ 10X power supply is comprised of two parts, the power adapter and the battery. The power adapter converts AC power from a wall outlet to the DC power required by the ALGIZ 10X. Your ALGIZ 10X comes with a universal AC-DC adapter. That means that you may connect the power cord to any 100V-120V as well as 220V-240V outlets without using power converters. Different countries may require an adapter to be used to connect the supplied standard AC power cord to a different standard.

Battery Power

The ALGIZ 10X is designed to work with two types of battery. A standard battery with 5300mAh and an extended battery with double the capacity. The battery life is especially dependent on the battery's condition, tablet usage, as well as the temperature.

Insertion of the Battery Pack

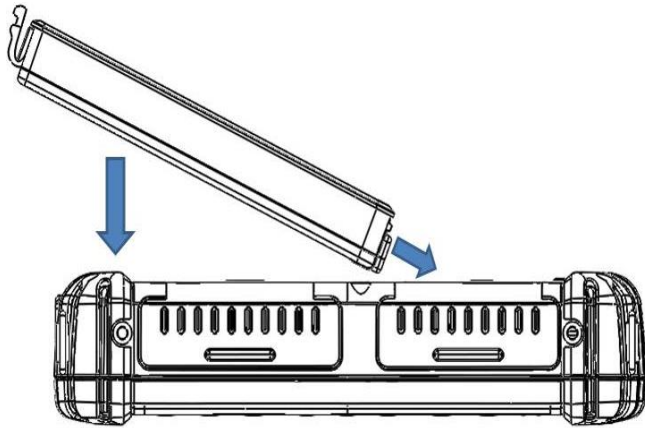

Removal of the Battery Pack

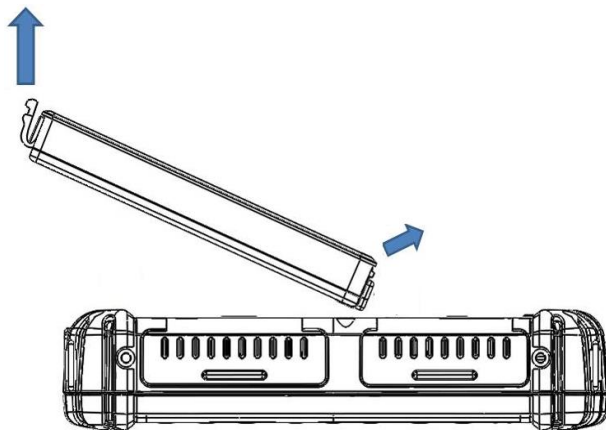

Charging the Battery

When the power adapter is plugged in, the battery automatically recharges regardless of whether your tablet PC is in the ON or OFF mode. It takes a couple of hours for the battery to be fully charged when the power is OFF and twice as long when the tablet PC is in use. When the charger LED indicator lights up orange, charging is required. The battery is charging when the red LED is permanently on. When the LED turns OFF, the battery pack is fully charged.



CAUTION: If unit is kept in storage for longer periods of time (6 months) without it being used, the hotswap battery might enter deep discharge, meaning it will no longer function as expected.

To prevent this, please make sure to, every 5-6 months, equip the unit with a standard or extended battery and connect ac charger. Power it on and leave it be for at least 2 hours to fully charge the hotswap battery.

Power Supply

The power for the Handheld rugged tablet PC is supplied by the power adapter and battery pack, the power rating and manufacturer information are listed as below. For safety reasons, the adapter must be connected to ground (earth).

Power Adapter	Manufacturer: EDAC Power Electronics Co Ltd Model: EA10633B Input Rated: 100-240Vac, 2.0A, 50-60Hz. Output Rated: DC  19V, 3.42A.
Battery Pack	Manufacturer: T-Gee Electronic Co., Ltd Model: ALG10X-08A Rated: 5300mAh DC 7.4V



CAUTION: Do not attempt to fix or replace the battery, as this may cause an explosion! Only use the specified battery and follow the instructions in the manufacturer's user manual.

Starting ALGIZ 10X

Press the power button for 4 seconds to power on the ALGIZ 10X. Follow the Microsoft Windows on-screen instructions to get started with Windows.

Installing SIM Card, SD Card

Remove the SIM/SD card cover on the right side. This cover is secured with two screws. Insert the SIM card according to the picture.

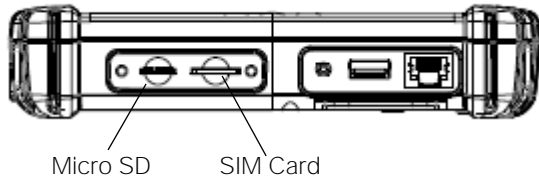

PART 3:
SOFTWARE

Hot-Tab

ALGIZ 10X has a pre-installed control application, Hot-Tab. The control application is used to monitor and control features such as brightness, volume, battery status, power to modules and system information.

The control application is accessed by pressing *menu* on the ALGIZ 10X.

To exit Hot-Tab: Click the menu key again or click the “x” in the top right corner.

Adjusting the LCD Brightness

The *Brightness Control* is accessed by pressing *menu* once and chooses “Setting”.

Check *Auto Brightness* to activate automatic brightness. With this item checked, ALGIZ 10X will adjust the LCD brightness based on the ambient light.

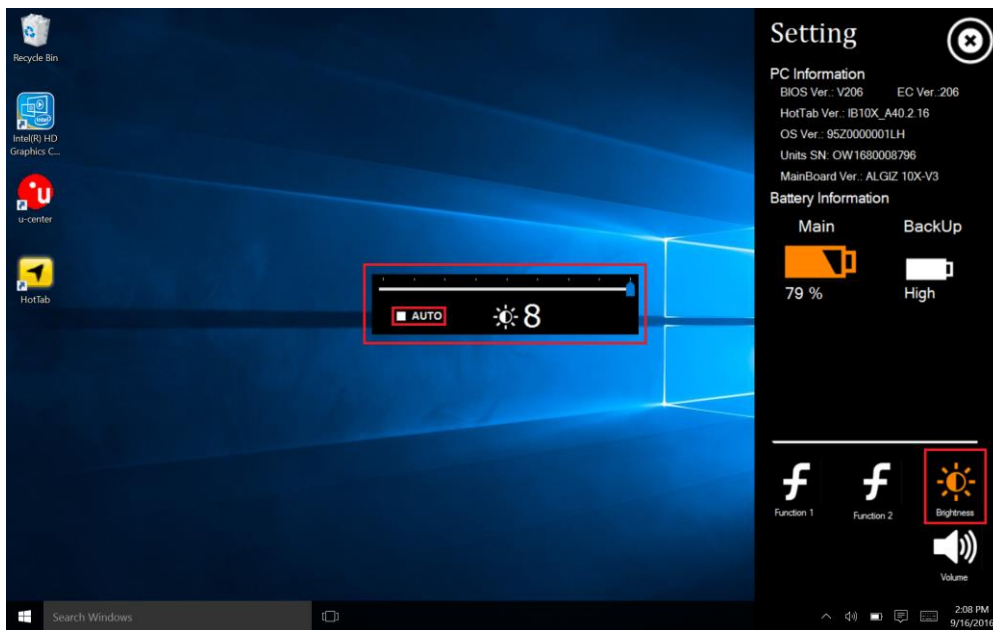

Adjusting the Speaker Volume

The *Speaker Control* is accessed by pressing *menu* -> *Setting*.

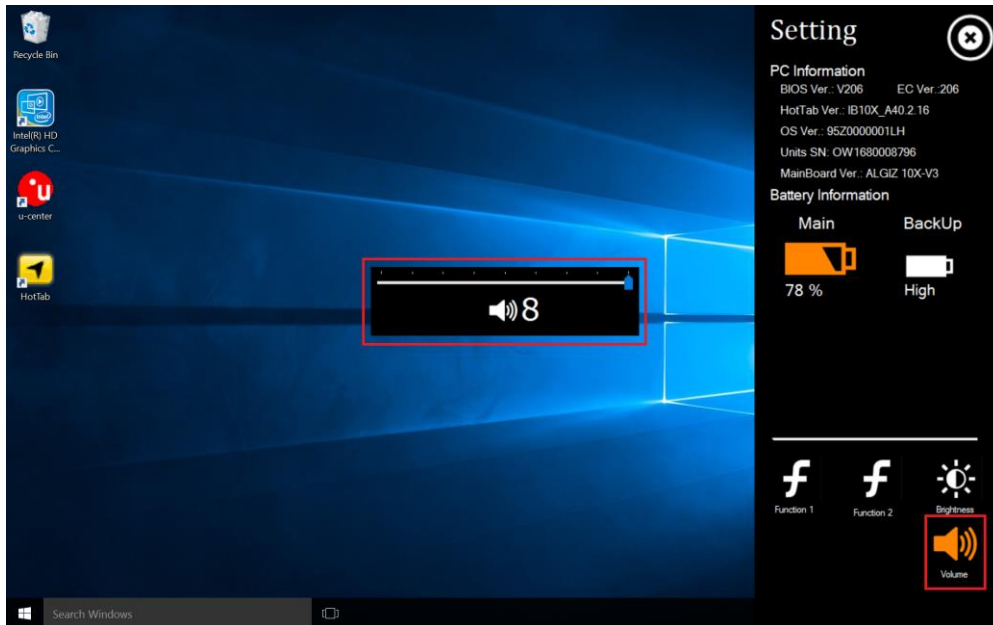

Battery Status

The *Battery status* is accessed by pressing *menu* -> *Setting*.

The ALGIZ 10X has a replaceable *Main* battery as well as a *second* built-in hot-swap battery. The hot-swap battery will activate once the main battery is empty or unplugged.

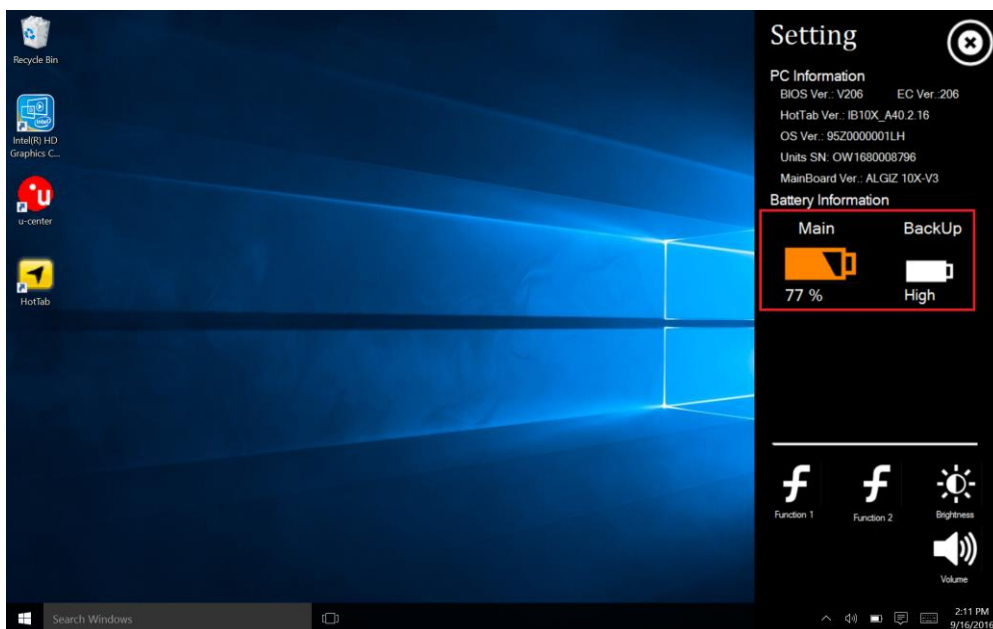

WLAN (1)

ALGIZ 10X can connect to IEEE 802.11 ac a/b/g/n networks operating on dual band 2.4/5GHz.

The *Function Control* is accessed by pressing *menu* -> *Device*. Check *Wi-Fi* to turn the Wi-Fi radio on. Uncheck *Wi-Fi* to turn it off.

Bluetooth (2)

Depending on your application, the Bluetooth module can give you capability for short-range wireless communication between devices without requiring a cable connection. The transmission can pass through walls, pockets and briefcases as long as the two devices are within a range of around 10 meters.

The *Function Control* is accessed by pressing *menu* -> *Device*. Check *Bluetooth* to turn the Bluetooth radio on. Uncheck *Bluetooth* to turn it off.



WWAN (LTE) - Optional

The ALGIZ 10X is prepared for WWAN (LTE) connectivity. If you have a WWAN modem installed, then navigate to the *WWAN* by pressing *menu* -> *Device*. Check *WWAN 3G/4G* to turn the WWAN on/off.

Note: You must install a SIM card in order for the ALGIZ 10X to access a WWAN network.

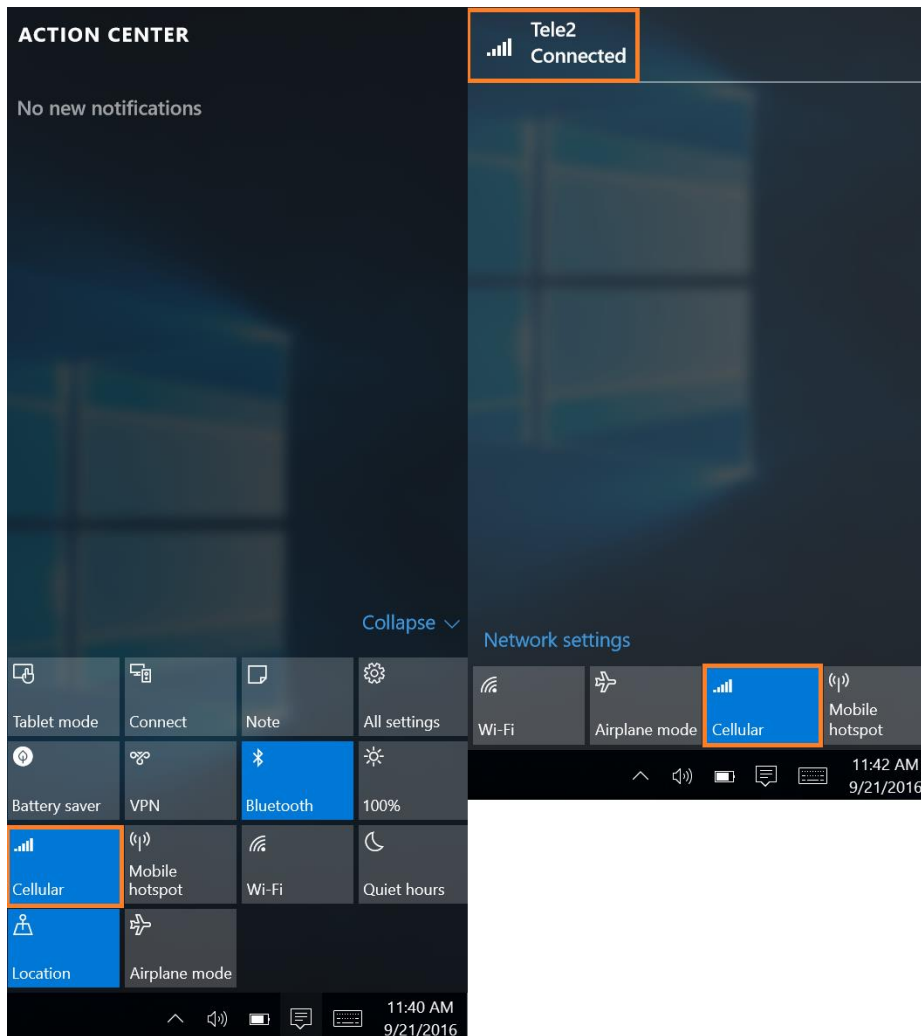

GPS

ALGIZ 10X is equipped with a dedicated GPS receiver for optimum performance.

The *Function Control* is accessed by pressing *menu* -> *Device*. Check *GPS* to turn the GPS receiver on. Uncheck *GPS* to turn it off.

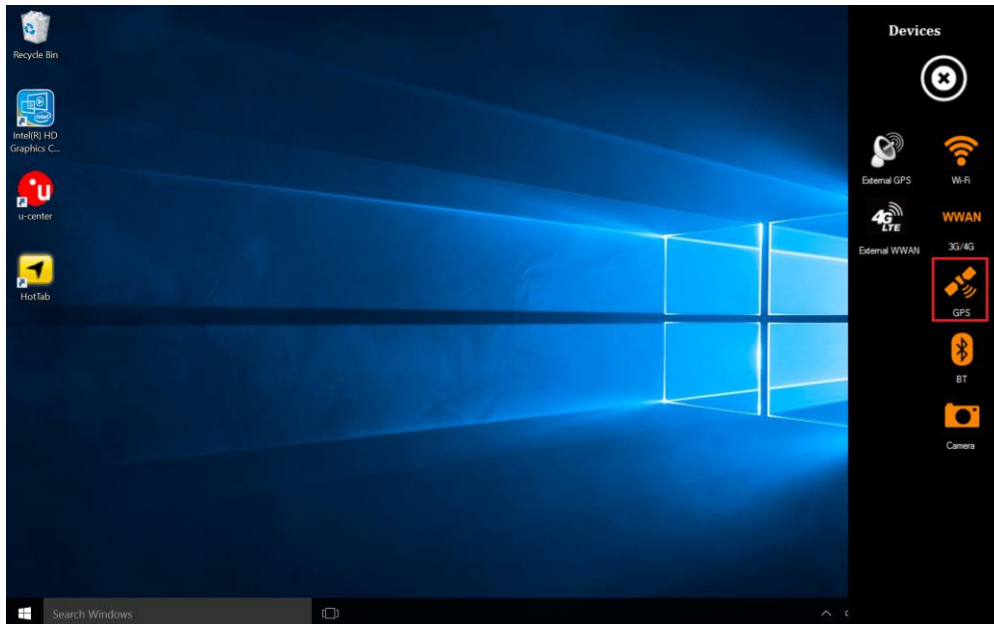

The GPS evaluation software, U-Center, is accessed by double-clicking the *U-Center icon* available on the desktop.

Set the *port* to COM3

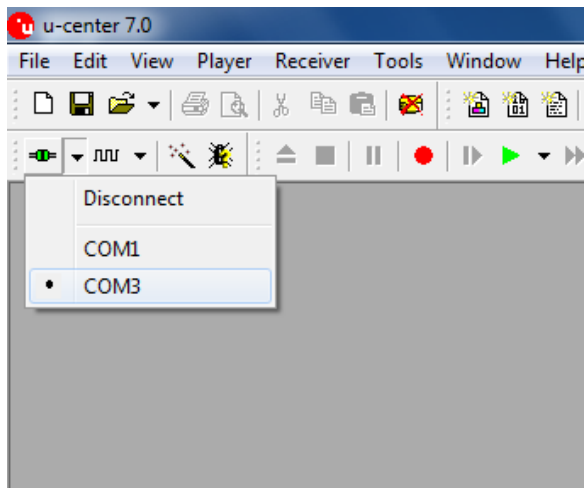

Set *Baud rate* to 9600

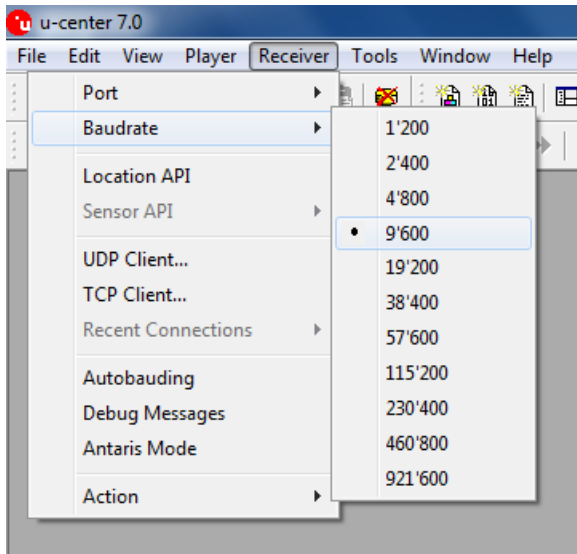

GPS will now start looking for satellites to calculate its position. This procedure may take from a few seconds to a few minutes depending on satellite positions, interference, environmental factors and radio noise.

Tip: See the U-Center manual for more information about this GPS evaluation software.

Camera

The ALGIZ 10X has a built-in 5-megapixel camera.

The *Function Control* is accessed by pressing *menu* -> *Device*. Check *Camera* to turn the Camera on. Uncheck *Camera* to turn it off.



Or press *menu* and click the *Camera* icon to start the Camera.

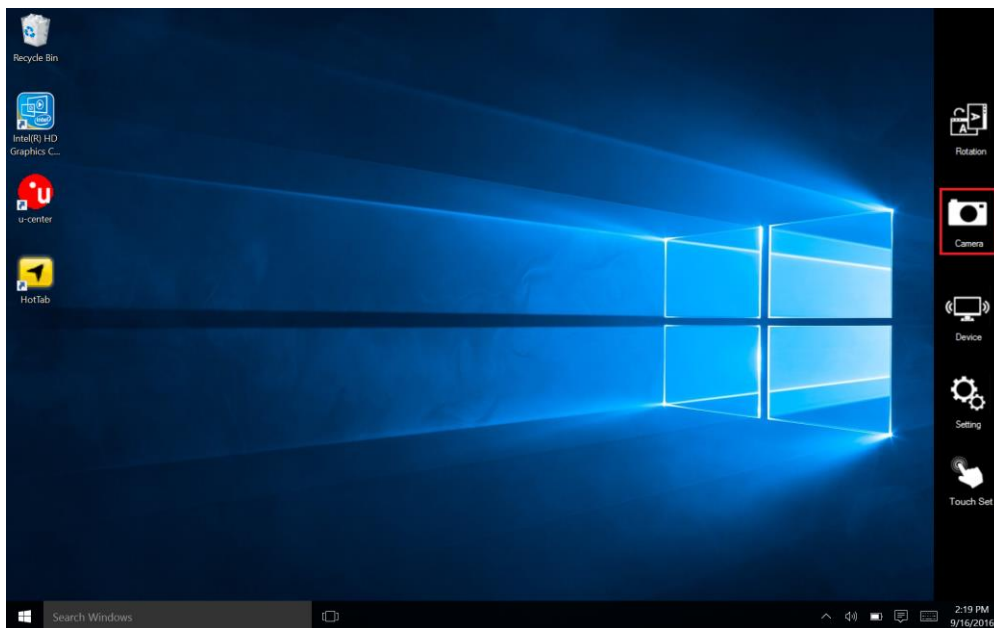

In the  settings you can control the destination folder for saved pictures or videos, previews, as well as image resolution.

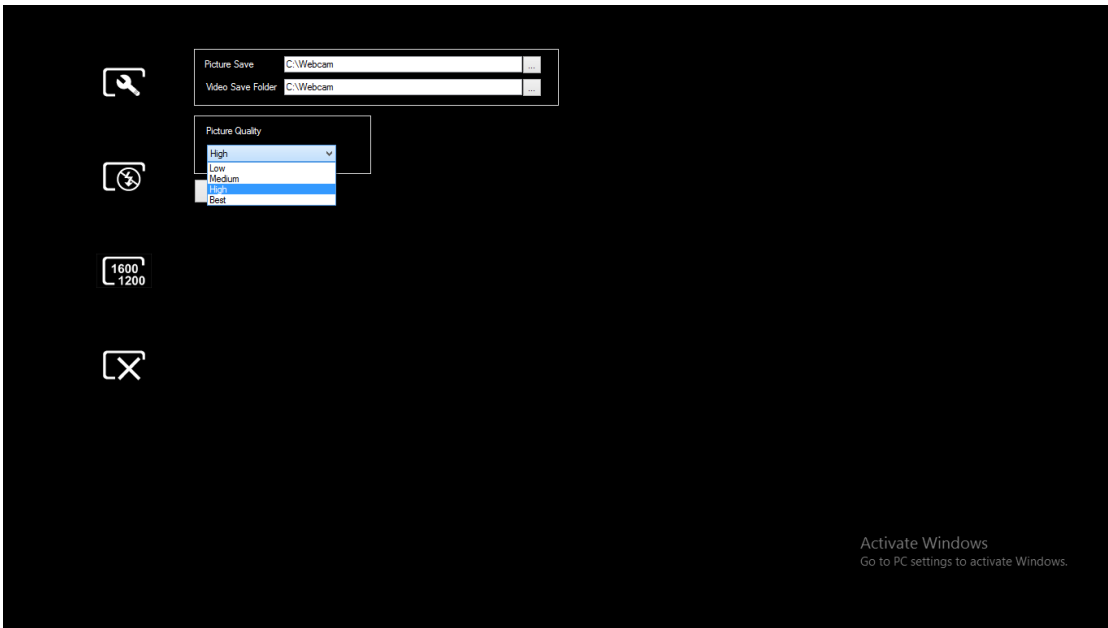

In the  settings you can control the flash light mode to on/off/auto.



In the  settings you can control the image resolution.



In the  settings you can switch to photograph or video mode.



In the  settings you can take a picture.



External GPS Antenna

The *Function Control* is accessed by pressing *menu* -> *Device*. Check *External Antenna (auto)* to activate an external antenna installed on the vehicle dock Alg10X-05A/05B. When this item is checked, Alg10X will automatically switch to the external antenna when the unit is docked. Do not check this item unless you have an external antenna installed on your Alg10X vehicle dock. Uncheck *External GPS (auto)* to turn this feature off.



External WWAN Antenna

The *Function Control* is accessed by pressing *menu* -> *Device*. Check *External WWAN (auto)* to activate an external antenna installed on the vehicle dock Alg10X-05A/05B. When this item is checked, Alg10X will automatically switch to the external antenna when the unit is docked.

Do not check this item unless you have an external antenna installed on your Alg10X vehicle dock. Uncheck *External WWAN (auto)* to turn this feature off.

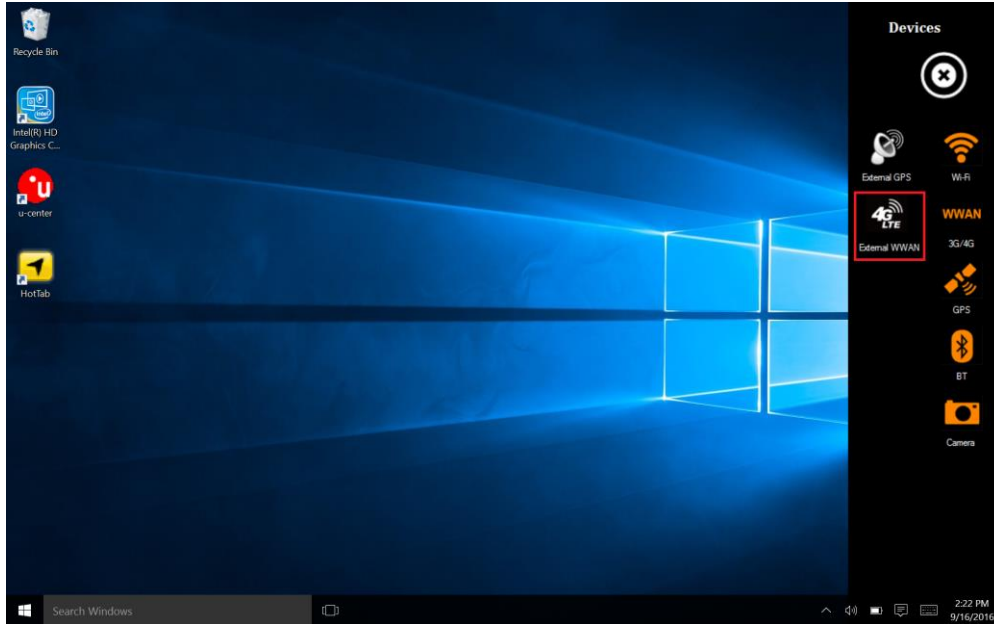

System Information

Press *menu* -> *Setting* to view system information. Please have this information ready if you are contacting Handheld support.

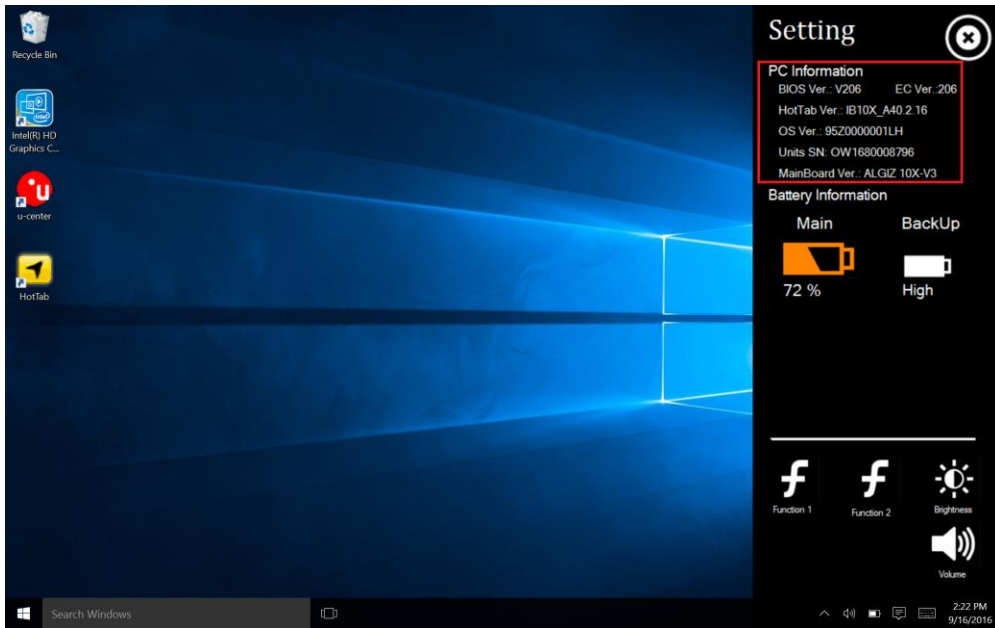

PART 4:
REGULATORY INFORMATION

FCC Compliance Statement

This device complies with Part 15 of the FCC Rules. Operation is subject to the following two conditions:

1. This device must not cause harmful interference, and
2. This device must be able to withstand any interference received, including interference that may cause undesired operation.

FCC Warning

This equipment has been tested and found to comply with the limits for a Class B digital device, pursuant to Part 15 of the FCC Rules. These limits are designed to provide reasonable protection against harmful interference in a residential installation. This equipment generates, uses and can radiate radio frequency energy and, if not installed and used in accordance with the instructions, may cause harmful interference to radio communications. However, there is no guarantee that interference will not occur in a particular installation. If this equipment does cause harmful interference to radio or television reception, which can be determined by turning the equipment off and on, the user is encouraged to try to correct the interference by one or more of the following measures:

- Reorienting or relocating the receiving antenna.

Increasing the distance between the equipment and the receiver.

- Connecting the equipment to a different outlet from that to which the receiver is connected.
- Consulting the dealer or an experienced radio/TV technician for help.

Caution:

To comply with the limits for an FCC Class B computing device, always use the shielded signal cord supplied with this unit. The Federal Communications Commission warns that changes or modifications to the unit not **expressly approved by the party responsible for compliance could invalidate the user's authority to operate the equipment.**

FCC RF Radiation Exposure

This equipment complies with the FCC RF radiation exposure limits stipulated for an uncontrolled environment. This device and its antenna must not be co-located or operated in conjunction with any other antennas or transmitters. To comply with FCC RF exposure compliance requirements, the antenna used for this transmitter must be installed so as to provide a separation distance of at least 20 cm from all persons and must not be co-located or operated in conjunction with any other antennas or transmitters.

Copyright Notice

Copyright © 2010 Handheld Group AB, ALL RIGHTS RESERVED. No part of this document may be reproduced, copied, translated or transmitted in any form or by any means, electronic or mechanical, for any purpose, without the prior written permission of the original manufacturer.

Trademark Acknowledgement

Brand and product names are trademarks or registered trademarks of their respective owners.

Disclaimer

Handheld Group AB reserves the right to make any product changes without notice, including to circuits and/or software described or contained in this manual, in order to improve design and/or performance. Handheld Group AB assumes no responsibility or liability for the use of the described product(s), conveys no license or title under any patent, copyright, or mask works rights to these products and makes no representations or warranties that these products are free from patent, copyright, or mask works rights infringement, unless otherwise specified. Applications described in this manual are for illustration purposes only. Handheld Group AB makes no representation or warranty that such applications will be suitable for the specified use without further testing or modification.

Customer Service

Support is provided by Handheld. Visit our website at www.handheldgroup.com to find updated information about the product. You can also contact your distributor, sales representative or our customer support center for further assistance. If you contact our customer support center please have the following information ready before you call:

Product serial number

Peripheral attachments

Software (OS, version, application software, etc.)

Description of complete problem

The exact wording of any error messages with print screen images

In addition to this, free technical support is available from our engineers during working hours. We are always ready to provide advice on application requirements or specific information about the installation and operation of any of our products. Please do not hesitate to call or e-mail us.

Manufacturer: Handheld Group AB

Address: Handheld Group AB, Kinnegatan 17 A, SE-531 33, Lidköping, Sweden

TEL: +46 (0) 510-54 71 70 FAX: +46 (0) 510-282 05